

MANUFACTURED IN AMERICA

2025-2026

FIRE & EMS

PROFESSIONAL WARNING
AND LIGHTING

A comprehensive guide to Whelen's
warning and lighting products



WHELEN ENGINEERING COMPANY, INC.



WHELEN[®]
MANUFACTURED IN AMERICA

To run toward danger when everyone else is running away, you must have trust in the team that runs alongside you and in the companies that provide the critical tools you use to stay safe. We're proud to have earned your trust as the leading manufacturer of the products you rely on to perform wherever and whenever you need them most. Our longstanding commitment to excellence and innovation is the foundation of our legacy, and since 1952, we've proudly designed and manufactured our products right here in America.

We're driven by our mission to protect you as you protect and serve your community.

And we're with you all the way, no matter where your rig takes you.

Clearing the way.

Illuminating the scene.

Sending you home safe night after night to the ones you love.

We never left, and we're here to stay.

WHELEN[®]
ENGINEERING COMPANY INC.



TABLE OF CONTENTS

Whelen Cloud Platform®	6
Lightbars.....	8
Mini Lightbars	28
Lighthoods	31
Traffic Advisor™	53
Beacons	57
White Illumination	61
Dash & Deck	79
Control & Sirens	82
Lighting Certifications.....	90
Product Index.....	90
Icon Legend	91
Tech Glossary.....	91



Learn about our full line of emergency lighting and warning products by visiting us at whelen.com.



To download WeCad™, Whelen Command®, and Illumination Designer go to whelen.com/software-downloads.



Design and build custom vehicle setups with Illumination Designer by visiting illuminationdesigner.whelen.com.



@WhelenENG

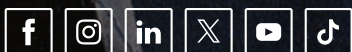



FIRE AND EMS LIFETIME WARRANTY

Whelen Engineering offers a limited lifetime warranty on several premium products for Fire and EMS markets. This coverage is a testament to our longstanding commitment to providing the highest quality, American-manufactured products that are built to last. Our products are known for their durability, exceptional performance, and long-life reliability—qualities that are imperative in the field when lives are on the line. Our mission is to provide you with the most reliable and comprehensive emergency warning products on the market. And with a lifetime warranty, you have added peace of mind knowing that no matter what happens, your purchase is covered.

Reach out to your Whelen sales representative for a list of covered products and with any questions about our Fire and EMS Lifetime Warranty.

WHELEN
ENGINEERING COMPANY INC.



WHELEN CLOUD PLATFORM[®]

GET ALL THESE FEATURES AND MORE



Digital Alerts: Send advance-warning alerts to notify motorists when emergency vehicles are approaching or stopped ahead. Real-time alerts improve motorists' situational awareness and reduce the likelihood of collisions by up to 90%.



Responder-to-Responder Alerts: Help prevent intersection collisions by automatically notifying other emergency vehicles in active response mode when approaching the same intersection.



Maintenance: Easily keep track of important vehicle data like service schedules, mileage, and engine hours enabling fleet managers to make informed decisions on repairs.



Geofence Controlled Tech: Utilize set geographic boundaries to trigger automated functions that can help keep first responders and motorists safe. Program lights and tones to change automatically as a vehicle approaches an intersection until it reaches a safe location.



Traffic Preemption: Mitigate risk and expedite emergency response times by automatically clearing intersections, reducing the likelihood of collisions, creating faster response times, and ensuring officers reach their destinations safely.



VEHICLE SAFETY GATEWAY[®] (VSG[®])

The VSG communicates to the Whelen Cloud using its own SIM card and a separate, low-profile antenna. Verizon frontline support available for qualifying users.

SPECS

- GPS location (integrated within the cellular modem)
- CenCom Core[®] system inputs (via ethernet)
- 8 logic inputs
- 1 CANport[™]
- 7.1" L x 4.6" W x 1.1" D

THE NEW STANDARD IN EMERGENCY SCENE SAFETY

The Whelen Cloud Platform® is a state-of-the-art, cloud-based vehicle communication system enhancing first responder safety and efficiency. With seamless connectivity between fleet vehicles and across agencies via cellular networks, our platform offers real-time digital alerts, geofence-controlled technology, and traffic preemption to ensure faster, safer responses. Effortlessly manage vehicle configurations and firmware updates over-the-air, and accurately pinpoint vehicle locations for coordinated operations. All data is securely accessible anytime, anywhere, allowing for optimal fleet organization and enhanced safety at roadside scenes.

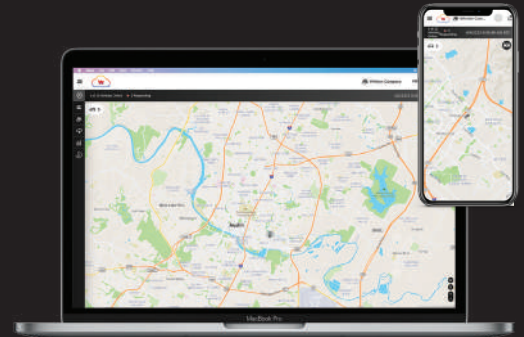

Easily manage and track fleet vehicle data from your computer, smartphone, or tablet.



**We're Always Adding
New Features!**

Visit whelen.com/cloud to learn more.



ANTENNA SPECS

- Aerodynamic design (exterior)
- Low-loss, high-quality cables from the antenna to the VSG® provide a strong signal
- IP67 rated (exterior)
- Exterior antenna: 7.08" L x 2.76" W x 2.41" D
- Interior antenna: 7.01" L x 2.36" W x 0.75" D

⚠ WARNING: This product may contain chemicals known to the State of California to cause cancer and birth defects or other reproductive harm. For more information, visit whelen.com/regulatory.

WHELEN®
MANUFACTURED IN AMERICA

LIGHTBARS

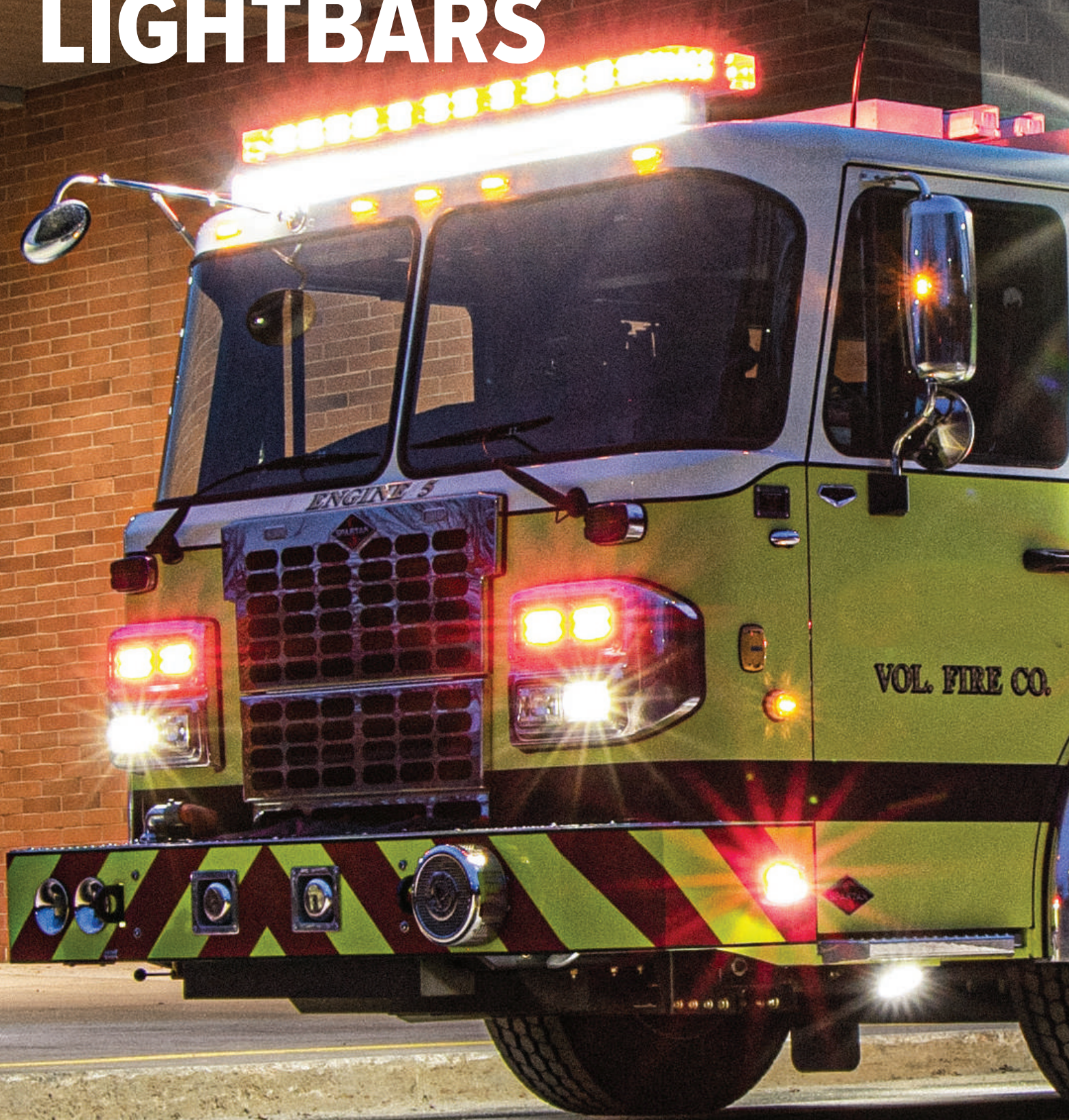

Freedom[®] IV Rota-Beam[™] Series



Features available across product family. May not apply to every model.



FEATURES

- SAE Class 1 Certified
- Extruded aluminum platform for long-life dependability
- Clear outer domes with Clear dividers
- Rotating Super-LED[®] Technology
- Hard-coated lenses resist environmental damage from sand, sun, salt, and road chemicals
- 16' (4.88m) exit cable, 25' (7.62m) exit cable for 71.50" (181.61cm) length bars

Model	Length	Description
F4R2****	55.10" (139.95cm)	4 Amber, Blue, White, Green or Red Single-Color Modules
F4R0****	59.90" (152.15cm)	4 Amber, Blue, White or Red Single-Color Modules
F4R7****	71.50" (181.61cm)	4 Amber, Blue, White or Red Single-Color Modules

Replace * symbol in model number with letter indicating color desired: A = Amber, B = Blue, C = White, G = Green, R = Red



OPTIONS

Consult current price list for full list of available options at whelen.com/literature

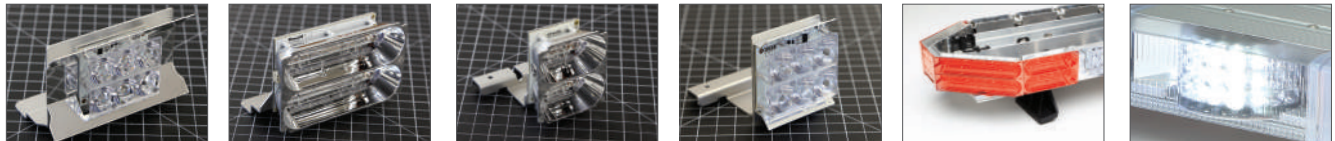

6-LED Take-Down

Long Lighthead

Short Lighthead

6-LED Alley Light

Filter

Rota-Beam Module

DIMENSIONS

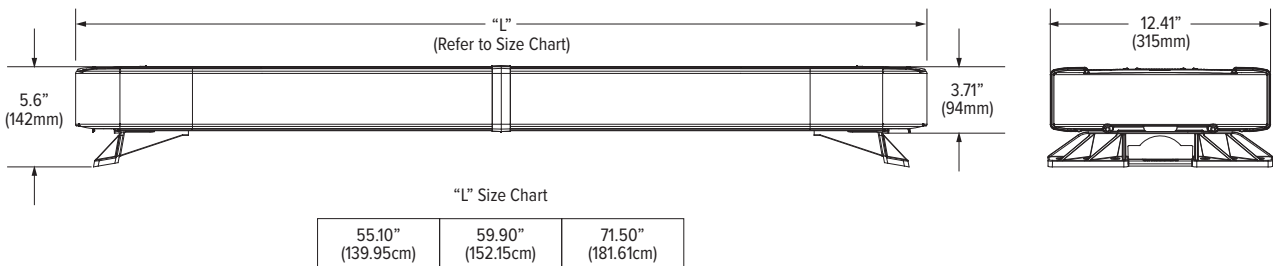

⚠ WARNING: This product may contain chemicals known to the State of California to cause cancer and birth defects or other reproductive harm. For more information, visit whelen.com/regulatory.

Freedom® IV DUO™ & DYAD™ Series



Download WeCad™ for models and options



Features available across product family. May not apply to every model.



K427DDDD

FEATURES

- WeCanX® models available
- SAE Class 1 Certified
- Extruded aluminum platform for long-life dependability
- Clear outer domes with Clear dividers
- Hard-coated lenses resist environmental damage from sand, sun, salt, and road chemicals
- 16' (4.88m) exit cable, 25' (7.62m) exit cable for 71.50" (181.61cm) length bars
- Dynamic Variable Intensity™ (DVI™) light patterns
- WeCan® DYAD two-level technology (single- or two-color) allows for individual control of each level of each lighthouse
- WeCan DUO™ technology allows for individual control of each color and each lighthouse, while providing a large aspect ratio of warning and illumination
- Linear Super-LED® optics
- Internal Photocell available

DIMENSIONS

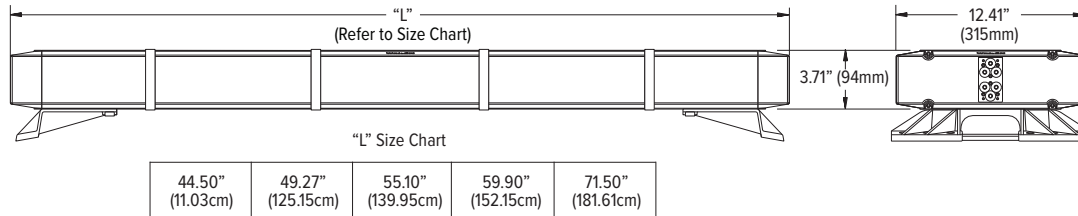

NFPA Freedom IV Lightbars



Features available across product family. May not apply to every model.



K420VLR

FEATURES

- Designed exclusively for the rigorous standards of the Fire/EMS market
- Dynamic Variable Intensity (DVI) light patterns for WeCanX Bars only
- Hard-coated lenses resist environmental damage from sand, sun, salt, and road chemicals
- Meets zone "A" upper requirements of NFPA 1900 specifications

44.50" (113.03cm)	49.27" (125.15cm)	55.10" (139.95cm)	59.90" (152.15cm)	71.50" (181.61cm)	Description
F4X4****	F4X8****	F4X2****	F4X0****	F4X7****	Low Current, Four Amber, Blue, White, Green, and/or Red, Single-Color Modules
F4W4****	F4W8****	F4W2****	F4W0****	F4W7****	WeCan®, Four Amber, Blue, White, and/or Red, Single or Two-Color Over/Under Modules
K4W4****	K4W8****	K4W2****	K4W0****	K4W7****	WeCanX®, Four Amber, Blue, White, and/or Red, Single or Two-Color Over/Under Modules
K42A####	K428####	K422####	K420####	K427####	WeCanX, Four Red/White or Blue/White DUO™ Modules
F42A####	F428####	F422####	F420####	F427####	WeCan Four Red/White or Blue/White DUO Modules

Model	Length	Description
F42DL#	24" (60.96cm)	One DUO Long 24 Super-LED® DUO Lighthouse, Red/White, Blue/White, Amber/White, Red/Blue, Red/Amber, Blue/Amber, or Amber/Green
F42DS#	12" (30.48cm)	One DUO Short 12 Super-LED DUO Lighthouse, Red/White, Blue/White, Amber/White, Red/Amber, or Blue/Amber
F42WA#	12" (30.48cm)	One DUO Short 12 Super-LED DUO Alley/Warning Light, Red/White, Blue/White, Amber/White, Red/Amber, Blue/Amber, or Amber/Green

Replace * symbol in model number with letter indicating color desired: A = Amber, B = Blue, C = White, G = Green, R = Red
 Replace # in model number with interleaved color desired: D = Red/White, E = Blue/White, F = Amber/White, J = Red/Blue, K = Red/Amber, M = Blue/Amber, P = Amber/Green



OPTIONS

Consult current price list for full list of available options at whelen.com/literature



6-LED Take-Down



Long Lighthouse



Short Lighthouse

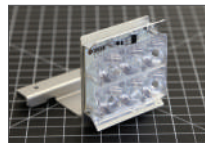

6-LED Alley Light



Filter



Rota-Beam™ Module



Miovision Opticom™
Emitter 795H

NFPA WECANX MODELS

55" (140cm)	60" (152cm)	72" (183cm)	Description
K422VLB	K420VLB	K427VLB	Four Blue Corners and Four Front (Two Blue/Two White)
K422VLJ	K420VLJ	K427VLJ	Four Corners (Two Red Driver Side and Two Blue Passenger Side) and Four Front (One Blue/One Red/Two White)
K422VLR	K420VLR	K427VLR	Four Red Corners and Four Front (Two Red/Two White)
K422QLB	K420QLB	K427QLB	Two Blue Corners, Two Blue Ends and Four Front (Two Blue/Two White)
K422QLJ	K420QLJ	K427QLJ	Two Corners, Two Ends (Two Red Driver Side and Two Blue Passenger Side) and Four Front (One Red/One Blue/Two White)
K422QLR	K420QLR	K427QLR	Two Red Front Corners and Four Front (Two Red/Two White) and Two End Red, Square Ends

NFPA LOW CURRENT MODELS

55" (140cm)	60" (152cm)	72" (183cm)	81" (205cm)	92" (243cm)	Description
F4N2VLED	F4N0VLED	F4N7VLED	F4N1VLED	F4N9VLED	Freedom® IV LC Series, Four Red Corners and Four Front (Two Red/Two White) with Angled Ends
F4N2QLED	F4N0QLED	F4N7QLED	F4N1QLED	F4N9QLED	Freedom IV LC Series, Two Red Front Corners, Two Red Side-Facing and Four Front (Two Red/Two White)

⚠ WARNING: This product may contain chemicals known to the State of California to cause cancer and birth defects or other reproductive harm. For more information, visit whelen.com/regulatory.

Liberty™ II Series



Download WeCad™ for models and options



Features available across product family. May not apply to every model.

ISOLO™ DUO™ TRIO™
PROCLERA™ PROFOCUS™



FEATURES

- WeCanX® models available
- SAE Class 1 Certified
- Advanced Thermal Design improves LED performance during extended operation
- Aluminum top repels hail and other environmental damages
- Extruded aluminum platform
- Center dividers with liquid injection molded seals protect internal components from water intrusion
- One piece uni-dome construction with a single sealing point assures lightbar integrity in all weather conditions
- Proclera® Silicone Optics (available in take-down lights)
- Hard-coated lenses resist environmental damage from sand, sun, salt, and road chemicals
- Plug & Play into Whelen WeCanX® products
- Clear, Smoked, or Color lenses available
- Internal Photocell available

43.22" (109.78cm)	48" (121.92cm)	53.75" (136.53cm)	Description
WeCan® Models			
IX4***	IX8***	IX2***	SOLO™, Single-Color, Amber, Blue, White and/or Red
IW4***	IW8***	IW2***	Single-Color, Amber, Blue, White and/or Red
IB4***	IB8***	IB2***	DUO™, Single-Color, Amber, Blue, White and/or Red
IB4####	IB8####	IB2####	DUO Color, Amber, Blue, Green and/or Red
WeCanX® Models			
BW4***	BW8***	BW2***	Single-Color, Amber, Blue, White and/or Red
-	BH8***	BH2***	Single-Color, Amber, Blue, White and/or Red, with Center Section for 795H, Strobe or Center LED Warning
BB4***	BB8***	BB2***	Single-Color, Amber, Blue, White and/or Red
-	BJ8***	BJ2***	Single-Color, Amber, Blue, White and/or Red, with Center Section for 795H, Strobe or Center LED Warning
-	BJ8####	BJ2####	DUO Color, Amber, Blue, White, Green and/or Red, with Center Section for 795H, Strobe or Center LED Warning
BB4####	BB8####	BB2####	DUO Color, Amber, Blue, White, Green and/or Red
B34++++	B38++++	B32++++	Four TRIO Colors
-	BH38++++	BH32++++	Four TRIO Colors, with Center Section for 795H, Strobe or Center LED Warning

Replace * symbol in model number with letter indicating color desired: A = Amber, B = Blue, C = White, G = Green, R = Red
 Replace # in model number with interleaved color desired: D = Red/White, E = Blue/White, F = Amber/White, J = Red/Blue, K = Red/Amber, L = Red/Green, M = Blue/Amber, N = Blue/Green, P = Amber/Green
 Replace + symbol in model number with numeral indicating TRIO Color desired: 1 = Red/Blue/White, 2 = Red/Blue/Amber, 3 = Red/White/Amber, 4 = Blue/White/Amber, 5 = Red/Blue/Green, 6 = Red/White/Green, 7 = Blue/White/Green



OPTIONS

Consult current price list for full list of available options at whelen.com/literature



Color Tops



V2V Sync Module



Filter



Short Lighthead



3-LED Proclera®
Take-Down



Alley Light



Long Lighthead



12-LED Take-Down



Miovision Opticom™
Emitter 795H

DIMENSIONS

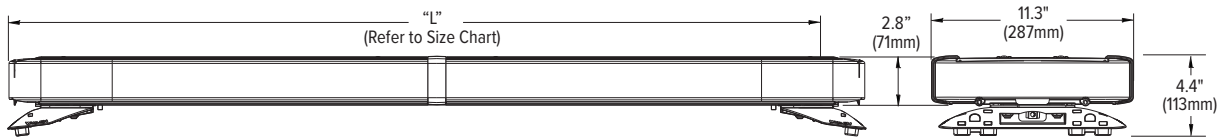

"L" Size Chart

43.22" (109.78cm)	48" (121.92cm)	53.75" (136.53cm)
----------------------	-------------------	----------------------



⚠ WARNING: This product may contain chemicals known to the State of California to cause cancer and birth defects or other reproductive harm. For more information, visit whelen.com/regulatory.

Justice® Series



Download WeCad™ for models and options



Features available across product family. May not apply to every model.

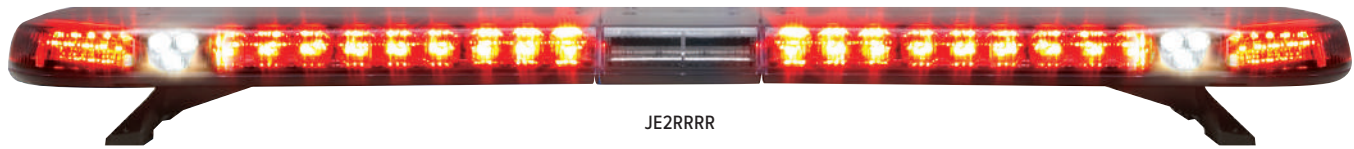

JE2RRRR

FEATURES

- SAE Class 1 Certified
- Advanced Thermal Design improves LED performance during extended operation
- Extruded aluminum platform and polycarbonate base
- Hard-coated lenses resist environmental damage from sand, sun, salt, and road chemicals
- Easily upgraded or serviced in the field
- Plug & Play into Whelen WeCanX® products
- Clear, Smoked, or Color lenses available

DIMENSIONS

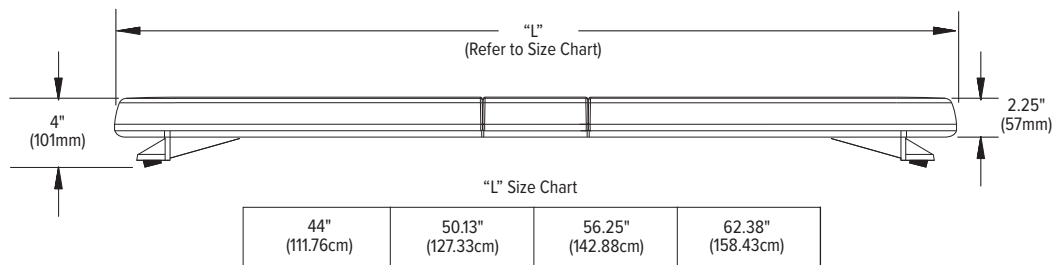

NFPA Justice Lightbars



Features available across product family. May not apply to every model.

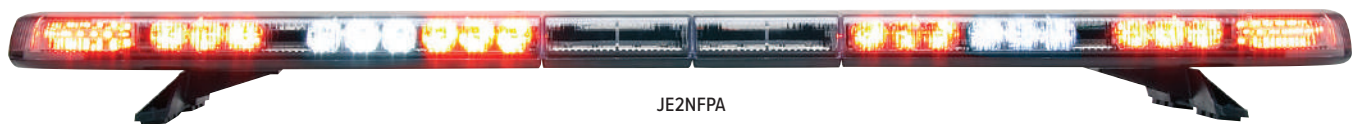

JE2NFPA

FEATURES

- Designed exclusively for the rigorous standards of the Fire/EMS market
- Hard-coated lenses resist environmental damage from sand, sun, salt, and road chemicals
- Meets zone "A" upper requirements of NFPA 1900 specifications

44" (111.76cm)	50.13" (127.33cm)	56.25" (142.88cm)	62.38" (158.43cm)	Description
Justice® JC Competitor™ Series Super-LED®				
JC4****	JC8****	JC2****		Four Extended Nine Diode Linear-LED® Corners, Amber, Blue, White, Green and/or Red
JE4****	JE8****	JE2****	JE0****	Four Standard Six Diode Linear-LED Corners, Amber, Blue, White, Green and/or Red
Justice Super-LED WeCan® Series				
JV4****	JV8****	JV2****		Four Amber, Blue, White, Green and/or Red
Justice DUO™ RX WeCanX® Series				
RX4####	RX8####	RX2####		DUO Color, Red/White, Blue/White, Amber/White, Red/Blue, Red/Amber, Blue/Amber

Replace * symbol in model number with letter indicating color desired: A = Amber, B = Blue, C = White, G = Green, R = Red
 Replace # in model number with interleaved color desired: D = Red/White, E = Blue/White, F = Amber/White, J = Red/Blue, K = Red/Amber, M = Blue/Amber, P = Amber/Green



OPTIONS

Consult current price list for full list of available options at whelen.com/literature



CON3™ Module with Spreader Optics



Full LIN6™



Take-Down



Alley Light

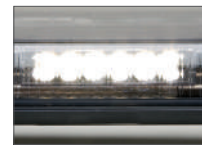

Work Light

NFPA MODELS

56.25" (142.88cm)	62.38" (158.43cm)	Description
JE2NFPA	JE0NFPA	Justice CS Series, Four Corner Red Linear-LED®s, Six Front CON3™s, Four Corner Red Linear-LED® Modules, Six Front CON3™ (Four Red/Two White) Modules, with Angled Ends
JE2QNFPFA	JE0QNFPFA	Justice CS Series, Two Red Linear-LED Front Corners, Two Red Side-Facing and Six Front CON3s (Four Red/Two White)



⚠ WARNING: This product may contain chemicals known to the State of California to cause cancer and birth defects or other reproductive harm. For more information, visit whelen.com/regulatory.

Edge® 9X Series



Features available across product family. May not apply to every model.



FEATURES

- SAE Class 1 Certified
- Powered by WeCanX® technology
- Available in two profiles
 - Short Profile: 1.88" (48mm) H
 - Tall Profile: 2.73" (69mm) H
- DUO™ Linear12™ LED and DUO Linear6™ LED Warning & Scene Take-Down/Alley
- Hard-coated lenses resist environmental damage from sand, sun, salt, and road chemicals
- Photocell included
- Passenger side cable exit
- Advanced Thermal Design improves LED performance during extended operation
- Molded polycarbonate Black tops provide protection from the elements
- 12/24 VDC
- Standard mounting feet
- Internal Photocell available

25" (63.50cm)	31" (78.74cm)	36" (91.44cm)	43" (109.22cm)	48" (121.92cm)	54" (137.16cm)	59" (149.86cm)	66" (167.64cm)	70" (177.80cm)	Description
EDGE 9XS Series									
9XS5####	9XS3####	9XS6####	9XS4####	9XS8####	9XS2####	9XS0####	9XS1####	9XS7####	4 Two-Color Amber, Blue, White, Green, and/or Red
EDGE 9XT Series									
9XT5####	9XT3####	9XT6####	9XT4####	9XT8####	9XT2####	9XT0####	9XT1####	9XT7####	4 Two-Color Amber, Blue, White, Green, and/or Red

OPTIONS

Model	Description
9SXL#	One DUO Color Long Super-LED® Lighthouse, Amber, Blue, White, Green, and/or Red
9SXL***	One Long Super-LED Lighthouse, Split-Color Primary Warning with Full-Color Secondary Warning for Center Mount on 31", 43" and 54" Lightbars Only
9SXTW*	One DUO Color Super-LED Take-Down or Alley Light, Red/White, Blue/White, Amber/White, or Green/White
9SXT	Super-LED Take-Down or Alley Lights, White, Pair
9TXDL#	One DUO Color Long Super-LED Lighthouse, Amber, Blue, White, Green, and/or Red
9TXDL***	One Long Super-LED Lighthouse, Split-Color Primary Warning with Full-Color Secondary Warning for Center Mount on 31", 43" and 54" Lightbars Only
9TXTW*	One DUO Color Super-LED Take-Down or Alley Light, Red/White, Blue/White, Amber/White, or Green/White
9TXT	Super-LED Take-Down or Alley Lights, White, Pair
9SXDCBL	Driver Side Cable Exit
CCP	Core® Control Point for Use with WeCanX Devices when NOT Using CenCom Core®
9XEND*	Colored Top, End, for 9X Series, Additional Charge When Purchased with Edge 9X Lightbar, Amber, Blue, and Red
9XSCNT*	Colored Top, Single Section, for 9X Series, Additional Charge When Purchased with Edge 9X Lightbar, Amber, Blue, and Red
9XDCNT*	Colored Top, Double Section, for 9X Series, Additional Charge When Purchased with Edge 9X Lightbar, Amber, Blue, and Red
9TXBTTR	Two Super-LED Brake/Tail/Turn Lights with Red Color Filters
9TXBTTC	Two Super-LED Brake/Tail/Turn Lights with Clear Color Filters

Consult current price list for full list of available options at whelen.com/literature

For LEDs, replace * symbol in model number with letter indicating color desired:

A = Amber, B = Blue, C = White, G = Green, R = Red

For Colored Tops, replace * symbol in model number with color desired: A = Amber, B = Blue, R = Red

Replace # in model number with interleaved color desired: D = Red/White, E = Blue/White, F = Amber/White,

H = Green/White, J = Red/Blue, K = Red/Amber, L = Red/Green, M = Blue/Amber, N = Blue/Green P = Amber/Green





OPTIONS

Consult current price list for full list of available options at whelen.com/literature



DUO™ Linear12™ LED



Molded Polycarbonate
Black Tops



Hard-Coated
Polycarbonate Lenses



Adjustable Mounting Feet



Translucent Color Tops

DIMENSIONS

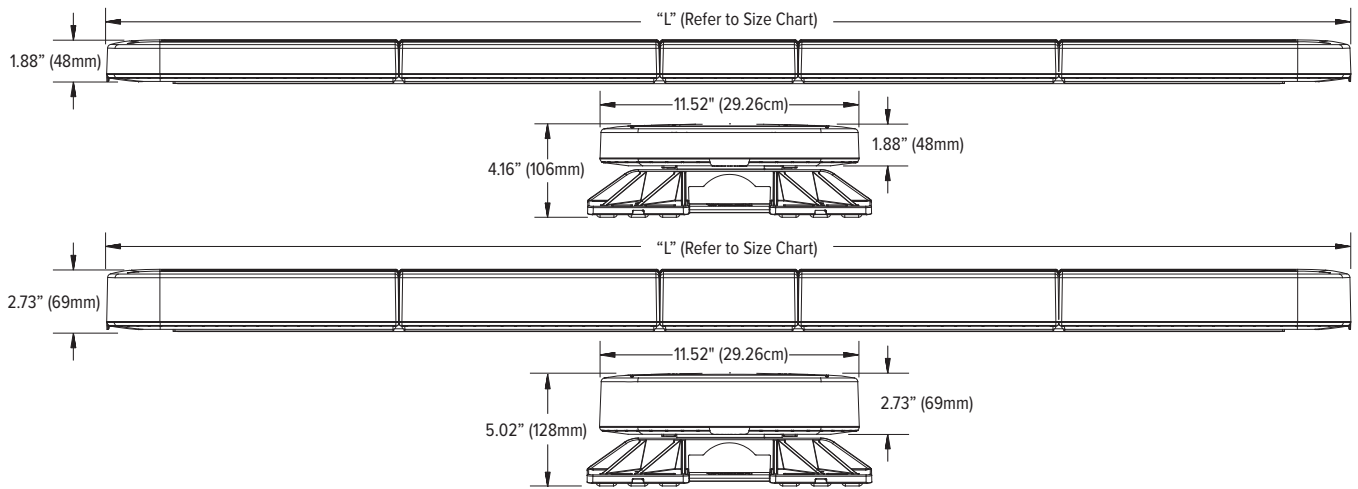

"L" Size Chart

25" (64cm)	31" (79cm)	36" (92cm)	43" (110cm)	48" (123cm)	54" (136cm)	59" (150cm)	66" (168cm)	70" (178cm)
---------------	---------------	---------------	----------------	----------------	----------------	----------------	----------------	----------------

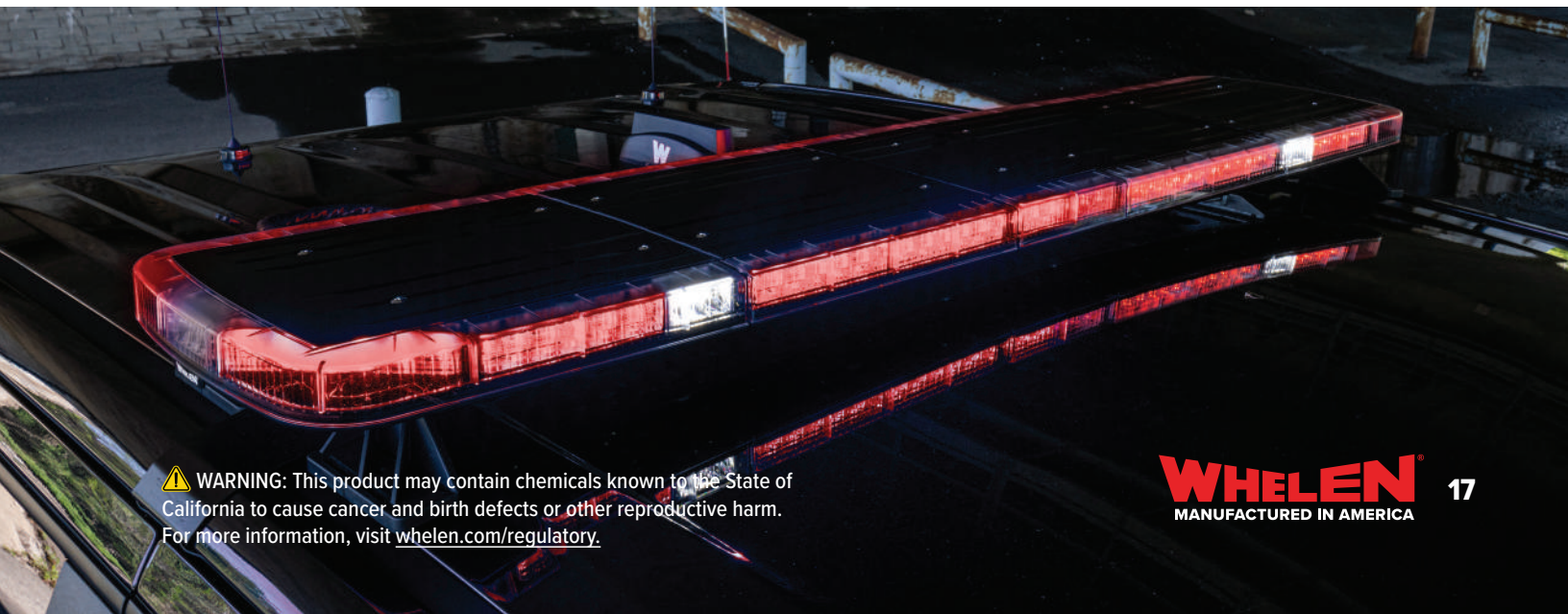

⚠ WARNING: This product may contain chemicals known to the State of California to cause cancer and birth defects or other reproductive harm. For more information, visit whelen.com/regulatory.

WHELEN
MANUFACTURED IN AMERICA

WeCanX[®] 2250



Download WeCad[™] for models and options



Features available across product family. May not apply to every model.



FEATURES

- Utilizes powerful T-Series[™] Lighthead with patented E Block[™] technology
- IP67 rated
- 3" (7.62cm) slimmer than 4500 series
- Flush mount (slide bolt)
- 10-30 VDC
- Powered by WeCanX technology
- Hard-coated lenses resist environmental damage from sand, sun, salt, and road chemicals
- Dynamic Variable Intensity[™] (DVI[™]) light patterns
- Functionality configurable in Whelen Command[®]
- Lighthead configurations easily defined within Whelen's WeCad Software
- DUO[™] support in warning light options
- Aerial recognition option
- Choose between two angled end caps or two flat end caps, you can also mix and match having 1 of each

Model	Length	Description
WeCanX 2250 Super-LED[®] with Angled End Caps, Ordered Separately		
WX2230	29.76" (75.59cm)	6 Lighthead and 2 Angled End Caps Required
WX2240	39.87" (101.27cm)	8 Lighthead and 2 Angled End Caps Required
WX2250	49.97" (126.92cm)	10 Lighthead and 2 Angled End Caps Required
WX2260	60.09" (152.63cm)	12 Lighthead and 2 Angled End Caps Required
WX2270	70.19" (178.28cm)	14 Lighthead and 2 Angled End Caps Required
WX2280	80.29" (203.94cm)	16 Lighthead and 2 Angled End Caps Required
WeCanX 2250 Super-LED with Flat End Caps, Ordered Separately		
WX2220F	21.87" (55.55cm)	4 Total Lighthead and 2 Flat End Caps Required
WX2230F	31.98" (81.23cm)	6 Total Lighthead and 2 Flat End Caps Required
WX2240F	42.08" (106.88cm)	8 Total Lighthead and 2 Flat End Caps Required
WX2250F	52.19" (132.56cm)	10 Total Lighthead and 2 Flat End Caps Required
WX2260F	62.29" (158.22cm)	12 Total Lighthead and 2 Flat End Caps Required
WX2270F	72.40" (183.90cm)	14 Total Lighthead and 2 Flat End Caps Required
WX2280F	82.50" (209.55cm)	16 Total Lighthead and 2 Flat End Caps Required
WeCanX 2250 Super-LED with Angled and Flat End Caps, Ordered Separately		
WX2225AF	25.82" (65.58cm)	5 Lighthead with 1 Angled End Cap on Right Side and 1 Flat End Cap on Left Side
WX2225FA	25.82" (65.58cm)	5 Lighthead with 1 Flat End Cap on Right Side and 1 Angled End Cap on Left Side
WX2235AF	35.93" (91.26cm)	7 Lighthead with 1 Angled End Cap on Right Side and 1 Flat End Cap on Left Side
WX2235FA	35.93" (91.26cm)	7 Lighthead with 1 Flat End Cap on Right Side and 1 Angled End Cap on Left Side
WX2245AF	46.03" (116.92cm)	9 Lighthead with 1 Angled End Cap on Right Side and 1 Flat End Cap on Left Side
WX2245FA	46.03" (116.92cm)	9 Lighthead with 1 Flat End Cap on Right Side and 1 Angled End Cap on Left Side
WX2255AF	56.14" (142.60cm)	11 Lighthead with 1 Angled End Cap on Right Side and 1 Flat End Cap on Left Side
WX2255FA	56.14" (142.60cm)	11 Lighthead with 1 Flat End Cap on Right Side and 1 Angled End Cap on Left Side
WX2265AF	66.24" (168.25cm)	13 Lighthead with 1 Angled End Cap on Right Side and 1 Flat End Cap on Left Side
WX2265FA	66.24" (168.25cm)	13 Lighthead with 1 Flat End Cap on Right Side and 1 Angled End Cap on Left Side
WX2275AF	76.35" (193.93cm)	15 Lighthead with 1 Angled End Cap on Right Side and 1 Flat End Cap on Left Side
WX2275FA	76.35" (193.93cm)	15 Lighthead with 1 Flat End Cap on Right Side and 1 Angled End Cap on Left Side



DIMENSIONS

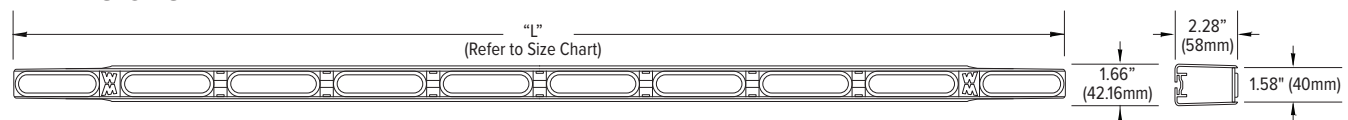

"L" Size Chart

30" (76cm)	40" (102cm)	50" (127cm)	60" (153cm)	70" (178cm)	80" (203cm)
------------	-------------	-------------	-------------	-------------	-------------



OPTIONS

Model	Description
22L#	Add One DUO Color Lighthouse, Red/White, Blue/White, Amber/White, Red/Blue, Red/Amber or Blue/Amber
22AEC	One Angled End Cap, No Charge When Purchased with a 2250 Series
CCP	Core® Control Point for Use with WeCanX Device when NOT Using CenCom Core®
22RECA	One Angled Right End Cap for Use with One Aerial Recognition Light, for Bars 30" to 50"
22LECA	One Angled Left End Cap for Use with One Aerial Recognition Light, for Bars 30" to 50"
22RECA2	One Angled Right End Cap for Use with One Aerial Recognition Light, for Bars 60" to 80"
22LECA2	One Angled Left End Cap for Use with One Aerial Recognition Light, for Bars 60" to 80"
22ARL*	Add One Aerial Recognition Light, Amber, Blue, White, Green or Red (22LECA(2))
22LOAD	Add One Load Light
22BLANK	Blank Filler Panel, Not Available for Angled End Caps
22EC	One Flat End Cap for Left or Right Side
SWX2C25	Substitute 25' (7.62m) Cable for Standard 15' (4.57m) Cable, For Use on 4-to 6-Lighthouse Models, with Flat End Cap Right Side Cable Exit, ONLY
SWX2C35	Substitute 35' (10.67m) Cable for Standard 15' (4.57m) Cable, For Use on 4-to 6-Lighthouse Models, with Flat End Cap Right Side Cable Exit, ONLY
SWX2C45	Substitute 45' (13.72m) Cable for Standard 15' (4.57m) Cable, For Use on 4-to 6-Lighthouse Models, with Flat End Cap Right Side Cable Exit, ONLY
SWX2C55	Substitute 55' (16.76m) Cable for Standard 15' (4.57m) Cable, For Use on 4-to 6-Lighthouse Models, with Flat End Cap Right Side Cable Exit, ONLY
SWX4C25	Substitute 25' (7.62m) Cable for Standard 15' (4.57m) Cable, For Use on 7-to 16-Lighthouse Models, with Flat End Cap Right Side Cable Exit, ONLY
SWX4C35	Substitute 35' (10.67m) Cable for Standard 15' (4.57m) Cable, For Use on 7-to 16-Lighthouse Models, with Flat End Cap Right Side Cable Exit, ONLY
SWX4C45	Substitute 45' (13.72m) Cable for Standard 15' (4.57m) Cable, For Use on 7-to 16-Lighthouse Models, with Flat End Cap Right Side Cable Exit, ONLY
SWX4C55	Substitute 55' (16.76m) Cable for Standard 15' (4.57m) Cable, For Use on 7-to 13-Lighthouse Models, with Flat End Cap Right Side Cable Exit, ONLY
SWX2C25G	Substitute 25' (7.62m) Cable for Standard 15' (4.57m) Cable, For Use on 4-to 6-Lighthouse Models with Angled End Cap Right Side Cable Exit, ONLY
SWX2C35G	Substitute 35' (10.67m) Cable for Standard 15' (4.57m) Cable, For Use on 4-to 6-Lighthouse Models, with Angled End Cap Right Side Cable Exit ONLY
SWX2C45G	Substitute 45' (13.72m) Cable for Standard 15' (4.57m) Cable, For Use on 4-to 6-Lighthouse Models, with Angled End Cap Right Side Cable Exit ONLY
SWX2C55G	Substitute 55' (16.76m) Cable for Standard 15' (4.57m) Cable, For Use on 4-to 6-Lighthouse Models with Angled End Cap Right Side Cable Exit, ONLY
SWX4C25G	Substitute 25' (7.62m) Cable for Standard 15' (4.57m) Cable, For Use on 7-to 16-Lighthouse Models with Angled End Cap Right Side Cable Exit, ONLY
SWX4C35G	Substitute 35' (10.67m) Cable for Standard 15' (4.57m) Cable, For Use on 7-to 16-Lighthouse Models with Angled End Cap Right Side Cable Exit, ONLY
SWX4C45G	Substitute 45' (13.72m) Cable for Standard 15' (4.57m) Cable, For Use on 7-to 16-Lighthouse Models with Angled End Cap Right Side Cable Exit, ONLY
SWX4C55G	Substitute 55' (16.76m) Cable for Standard 15' (4.57m) Cable, For Use on 7-to 13-Lighthouse Models with Angled End Cap Right Side Cable Exit, ONLY



Flat End Caps



Angled End Caps



Aerial Recognition Light



Blank Filler Panel

Consult current price list for full list of available options at whelen.com/literature.

Replace * symbol in model number with letter indicating color desired: A = Amber, B = Blue, R = Red, C = White

Replace # in model number with interleaved color desired: D = Red/White, E = Blue/White, F = Amber/White, H = Green/White,

J = Red/Blue, K = Red/Amber, L = Red/Green, M = Blue/Green, N = Blue/Amber, P = Amber/Green



⚠ WARNING: This product may contain chemicals known to the State of California to cause cancer and birth defects or other reproductive harm. For more information, visit whelen.com/regulatory.

Legacy® Series



Download WeCad™ for models and options



Features available across product family. May not apply to every model.



FEATURES

- WeCanX® models available
- SAE Class 1 Certified
- Advanced Thermal Design improves LED performance during extended operation
- Aluminum top repels hail and other environmental damages
- Extruded aluminum platform
- Center dividers with liquid injection molded seals protect internal components from water intrusion
- One piece uni-dome construction with a single sealing point assures lightbar integrity in all weather conditions
- Proclera® Silicone Optics (available in take-down lights)
- Hard-coated lenses resist environmental damage from sand, sun, salt, and road chemicals
- Plug & Play into Whelen WeCanX® products
- Clear, Smoked, or Color lenses available
- Internal Photocell available

43.22" (109.78cm)	48" (121.92cm)	53.75" (136.53cm)	Description
GS4****	GS8****	GS2****	SOLO™ WeCan® Single-Color, Amber, Blue, White, Green and/or Red
GB4****	GB8****	GB2****	DUO™ WeCan Single-Color, Amber, Blue, White, Green and/or Red
GB4####	GB8####	GB2####	DUO WeCan Two-Color Amber, Blue, White, Green and/or Red
Legacy Series WeCanX® Models			
ES4****	ES8****	ES2****	Four SOLO™ Single-Color, Amber, Blue, White, Green and/or Red
EB4****	EB8****	EB2****	Four DUO™ Single-Color, Amber, Blue, White, Green and/or Red
EB4####	EB8####		Four DUO Two-Color, Amber, Blue, White, Green and/or Red
E34++++	E38++++	E32++++	Four TRIO™ Colors

Replace * symbol in model number with letter indicating color desired: A = Amber, B = Blue, C = White, G = Green, R = Red
 Replace # in model number with interleaved color desired: D = Red/White, E = Blue/White, F = Amber/White, H = Green/White,
 J = Red/Blue, K = Red/Amber, L = Red/Green, M = Blue/Amber, N = Blue/Green, P = Amber/Green
 Replace + symbol in model number with numeral indicating TRIO Color desired: 1 = Red/Blue/White, 2 = Red/Blue/Amber,
 3 = Red/White/Amber, 4 = Blue/White/Amber, 5 = Red/Blue/Green, 6 = Red/White/Green



OPTIONS

Consult current price list for full list of available options at whelen.com/literature



Alley Light



3-LED Take-Down



6-LED Take-Down



Color Tops

DIMENSIONS

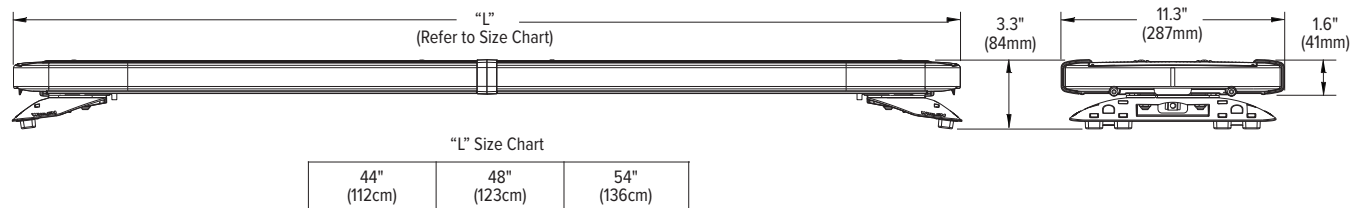

4500 Build-A-Bar Series



Features available across product family. May not apply to every model.

Download WeCad™ for models and options



45B20



45B72R



45B84R

FEATURES

- Hard-coated lenses resist environmental damage from sand, sun, salt, and road chemicals
- Available with or without SAE compliant front and rear LED clearance lights
- Pre-configured KKK-A-1822F compliant packages available
- Color or Clear outer lens
- Anodized aluminum extrusion
- Slide bolt mount

Model	Length	Height x Depth
45B±±	20" (51cm)	4.88" (124mm) H x 5.25" (133mm) D
	22" (56cm)	
	38" (96cm)	
	44" (112cm)	
	52" (132cm)	
	60" (152cm)	
	72" (183cm)	
	76" (193cm)	
	78" (198cm)	
	82" (208cm)	
45B±±*	84" (213cm)	
	86" (218cm)	
	88" (224cm)	
	90" (228cm)	
	92" (233cm)	
	94" (239cm)	
	96" (244cm)	
	98" (249cm)	

Replace * symbol in model number with A = Front Facing or R = Rear Facing
 ±± = Insert length, ±±* = Insert length, with LED ICC lights



OPTIONS

Consult current price list for full list of available options at whelen.com/literature



Rota-Beam™
Rotating LED Module



700 Series
Linear-LED™



LR11 LED
Load Light



End LED Clearance Lights

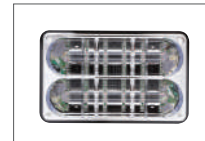

400 Series
Linear-LED



Angled Linear-LED
Corner



Miovision Opticom™
Emitter 795H

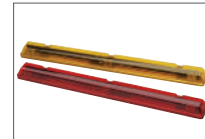

Center LED
Clearance Lights



Color Lenses



Aluminum Extrusion

⚠ WARNING: This product may contain chemicals known to the State of California to cause cancer and birth defects or other reproductive harm. For more information, visit whelen.com/regulatory.

Inner Edge® XLP Series



Download WeCad™ for models and options



Features available across product family. May not apply to every model.

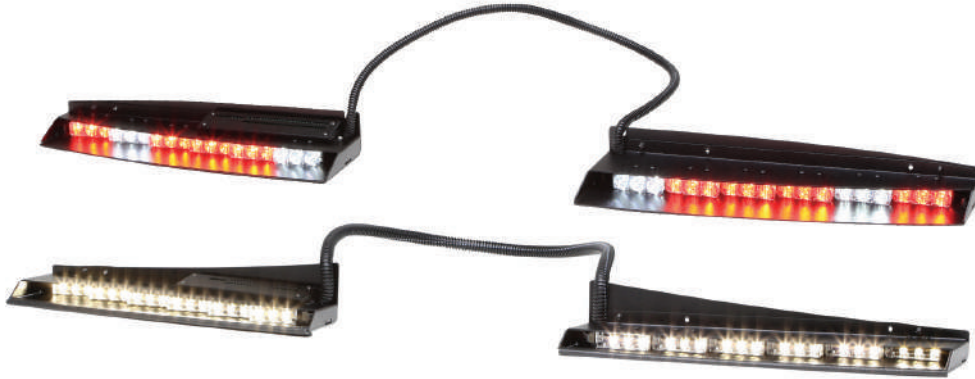

FEATURES

- WeCanX® models available
- SAE Class 1 Certified
- Upper front units mounts to visor anchor points
- Low Current models are available with SOLO™ light modules
- Blue lenses default to BroadBand Blue™
- Available as passenger side only or driver/passenger combo
- 38 Scan-Lock™ flash patterns
- Vehicle-specific housing minimizes flashback to vehicle passengers
- 19' (5.79m) cable included
- Refer to website for full list of models



Inner Edge® RST™ Series



Download WeCad™ for models and options



Features available across product family. May not apply to every model.



FEATURES

ITRAYL12 + (12) ISSR

- WeCanX® models available
- SAE Class 1 Certified
- Mounts to the rear headliner of SUVs and pickup trucks
- Drop-in lighthouse tray is universal, allowing for easy serviceability
- Lighthouse tray can be repurposed to a different vehicle by obtaining an alternate housing and mounting kit

- Low current models are available with SOLO™ light modules
- Plug & Play into Whelen WeCanX® products
- Vehicle-specific models available for the Chevrolet Silverado PPV/SSV, Silverado HD, Ford F-150, Ford F-150 Lightning, and Ford Super Duty

Model	Tray Description
ITRAYL8	8-Lamp Tray for Low Current SOLO Lighthoods
ITRAYL10	10-Lamp Tray for Low Current SOLO Lighthoods
ITRAYL12	12-Lamp Tray for Low Current SOLO Lighthoods
ITRAYW8	8-Lamp Tray for WeCan SOLO, DUO™ or TRIO™ Lighthoods
ITRAYW10	10-Lamp Tray for WeCan SOLO, DUO or TRIO Lighthoods
ITRAYW12	12-Lamp Tray for WeCan SOLO, DUO or TRIO Lighthoods
Model	Vehicle-Specific Housing Description
IS548	2021-2025 Chevy Tahoe PPV/SSV, 2021-2025 Chevy Suburban, Upper Rear Housing for Eight or Ten Modules
IS448	2016-2025 Dodge Durango, Upper Rear Housing for Eight or Ten Modules
IS488	2018-2024 Ford Expedition, Upper Rear Housing for Eight or Ten Modules
IS598	2024 Chevy Blazer EV PPV, Upper Rear Housing for Eight or Ten Modules. For Low Current only
IS578	2021-2024 Ford Mach-E, Upper Rear Housing for Eight Modules
IS508	2020-2025 Ford Police Interceptor Utility, Upper Rear Housing for Eight or Ten Modules

Model	Lighthouse Description
ISS*	One SOLO Lighthouse, Amber, Blue, White, Green or Red
ISD#	One DUO Lighthouse, Amber, Blue, White and/or Red
ISTBAG	One TRIO Lighthouse, Blue/Amber/Green
ISTBCA	One TRIO Lighthouse, Blue/White/Amber
ISTBGC	One TRIO Lighthouse, Blue/Green/White
ISTGAC	One TRIO Lighthouse, Green/Amber/White
ISTRAG	One TRIO Lighthouse, Red/Amber/Green
ISTRBA	One TRIO™ Lighthouse, Red/Blue/Amber
ISTRBC	One TRIO Lighthouse, Red/Blue/White
ISTRBG	One TRIO Lighthouse, Red/Blue/Green
ISTRCA	One TRIO Lighthouse, Red/White/Amber
ISTRGC	One TRIO Lighthouse, Red/Green/White
DEWCCP	Delete WeCan Control Point

Consult current price list for full list of available options at whelen.com/literature. Replace * symbol in model number with letter indicating color desired:

A = Amber, B = Blue, C = White, G = Green, R = Red
 Replace # in model number with interleaved color desired: D = Red/White, E = Blue/White, F = Amber/White, H = Green/White, J = Red/Blue, K = Red/Amber, L = Red/Green, M = Blue/Amber, N = Blue/Green, P = Amber/Green

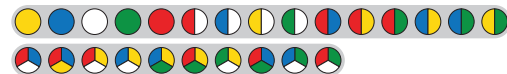

Inner Edge FST™ Series



Download WeCad™ for models and options



Features available across product family. May not apply to every model.



FEATURES

- WeCanX models available
- Meets SAE Class 1 specifications
- Upper front units mount to visor anchor points
- Low Current models are available in SOLO
- Plug & Play into Whelen WeCanX® products
- Proclera® Silicone Optics (available in take-down lights)
- 17' (5.18m) cable included

- Vehicle-specific housing minimizes flashback to vehicle passengers
- Models available for the Chevy Silverado, Chevy Tahoe/Suburban, Ram 1500, Ford Police Interceptor Utility, Ford F-150/F-250/F-350, Ford Expedition, Ford Transit, and Mercedes Sprinter
- Refer to website for full list of models

⚠ WARNING: This product may contain chemicals known to the State of California to cause cancer and birth defects or other reproductive harm. For more information, visit whelen.com/regulatory.

Outer Edge® Series



Download WeCad™ for models and options



Features available across product family. May not apply to every model.

FEATURES

- 6-lamp, 2-piece
- SAE Class 1 Certified
- Vehicle-specific vacuum-formed pillar housings offer easy serviceability
- Plug & Play into Whelen WeCanX® products
- Low Current models are available with SOLO™ lighthoods and feature Traffic Advisor™ patterns
- Fully encapsulated
- Hard-coated lenses resist environmental damage from sand, sun, salt, and road chemicals
- Each housing supports three ION® lighthoods



OEWS54

Clear Lens Model	Smoked Lens Model	Description
Outer Edge Rear Spoiler		
OEWS54	OEWS54X	2021-2025 Chevy Tahoe SSV/PPV, 2021-2025 Chevy Suburban, Requires Six SOLO™ OEION* Lighthoods
OEWS54	OEWS54X	2021-2025 Chevy Tahoe SSV/PPV, 2021-2025 Chevy Suburban,, Requires Six SOLO OEION* Lighthoods
OEWD54	OEWD54X	2021-2025 Chevy Tahoe SSV/PPV, 2021-2025 Chevy Suburban,, Requires Six DUO™ OEI2# Lighthoods
OEWT54	OEWT54X	2021-2025 Chevy Tahoe SSV/PPV, 2021-2025 Chevy Suburban,, Requires Six TRIO™ OEI3*** Lighthoods
OEWS50	OEWS50X	2020-2025 Ford Police Interceptor Utility, Requires Six TRIO OEI3*** Lighthoods
OEWD50	OEWD50X	2020-2025 Ford Police Interceptor Utility, Requires Six TRIO OEI3*** Lighthoods
OEWT50	OEWT50X	2020-2025 Ford Police Interceptor Utility, Requires Six TRIO OEI3*** Lighthoods
OEWS59	OEWS59X	2024 Chevy Blazer EV PPV, Requires Six DUO Lighthoods
OEWD59	OEWD59X	2024 Chevy Blazer EV PPV, Requires Six DUO Lighthoods
Outer Edge Rear Pillar		
RPLS44	RPLS44X	2019-2025 Dodge Durango Pursuit, Requires Six SOLO OEION* Lighthoods
RPWS44	RPWS44X	2019-2025 Dodge Durango Pursuit, Requires Six SOLO OEION* Lighthoods (Requires External Flasher for Individual Control)
RPWD44	RPWD44X	2019-2025 Dodge Durango Pursuit, Requires Six DUO OEI2# Lighthoods (Requires External Flasher for Individual Control)
RPWT44	RPWT44X	2019-2025 Dodge Durango Pursuit, Requires Six TRIO OEI3*** Lighthoods (Requires External Flasher for Individual Control)
RPLS54	RPLS54X	2021-2025 Chevy Tahoe PPV/SSV, 2024 Chevy Suburban, Requires Six SOLO OEION* Lighthoods
RPWS54	RPWS54X	2021-2025 Chevy Tahoe PPV/SSV, 2024 Chevy Suburban, Requires Six SOLO OEION* Lighthoods (Requires External Flasher for Individual Control)
RPWD54	RPWD54X	2021-2025 Chevy Tahoe PPV/SSV, 2024 Chevy Suburban, Requires Six DUO OEI2 Lighthoods (Requires External Flasher for Individual Control)
RPWT54	RPWT54X	2021-2025 Chevy Tahoe PPV/SSV, 2024 Chevy Suburban, Requires Six TRIO OEI3 Lighthoods (Requires External Flasher for Individual Control)
RPLS50	RPLS50X	2020-2025 Ford Police Interceptor Utility, Requires Six SOLO OEION* Lighthoods
RPWS50	RPWS50X	2020-2025 Ford Police Interceptor Utility, Requires Six SOLO OEION* Lighthoods (Requires External Flasher for Individual Control)
RPWD50	RPWD50X	2020-2025 Ford Police Interceptor Utility, Requires Six DUO OEI2 Lighthoods (Requires External Flasher for Individual Control)
RPWT50	RPWT50X	2020-2025 Ford Police Interceptor Utility, Requires Six TRIO OEI3 Lighthoods (Requires External Flasher for Individual Control)

Consult current price list for full list of available options at whelen.com/literature.

Replace * symbol in model number with letter indicating color desired: A = Amber, B = Blue, C = White, G = Green, R = Red

Replace # in model number with interleaved color desired: D = Red/White, E = Blue/White, F = Amber/White,

H = Green/White, J = Red/Blue, K = Red/Amber, L = Red/Green, M = Blue/Amber, N = Blue/Green, P = Amber/Green

Replace *** symbol in model number with letter indicating TRIO colors desired: BAC = Blue/Amber/White,

BAG = Blue/Amber/Green, RAC = Red/Amber/White, RAG = Red/Amber/Green, RBA = Red/Blue/Amber, RBC = Red/Blue/White

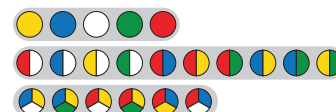

Dominator™ & Dominator Plus™ Series



Features available across product family. May not apply to every model.

Download WeCad™ for models and options



FEATURES

- SAE Class 1 Certified
- Low-profile surface mount housing designed for interior or exterior use
- Choice of TIR3™ or LINZ6™ Super-LED® modules
- Fully encapsulated for moisture, vibration, and corrosion resistance
- Internal self-contained electronics
- Hard-coated lenses resist environmental damage from sand, sun, salt, and road chemicals
- Slide bolt mount
- Extruded aluminum Black powder-coated housing

DOMINATOR MODELS

Model	Description
D2	2-Light, Requires 2 D*
D4	4-Light, Requires 4 D*
D6	6-Light, Requires 6 D*
D8	8-Light, Requires 8 D*
D*	TIR3 Super-LED Lighthouse, Amber, White, or Red

DOMINATOR PLUS MODELS

Model	Description
DP2	2-Light, Requires 2 DP*
DP4	4-Light, Requires 4 DP*
DP6	6-Light, Requires 6 DP*
DP8	8-Light, Requires 8 DP*
DP*	LINZ6 Super-LED Lighthouse, Amber, White, or Red

Replace * symbol in model number with letter indicating color desired: A = Amber, C = White, R = Red



DIMENSIONS

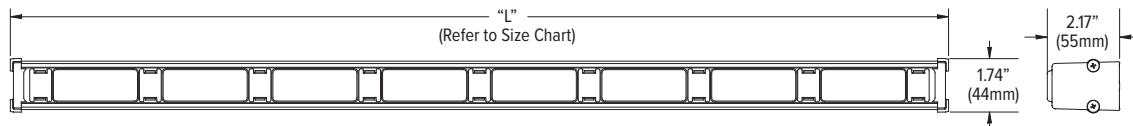

"L" Size Chart

7.11" (181mm)	14.21" (361mm)	23.26" (591mm)	30.36" (771mm)
------------------	-------------------	-------------------	-------------------

⚠ WARNING: This product may contain chemicals known to the State of California to cause cancer and birth defects or other reproductive harm. For more information, visit whelen.com/regulatory.

Tracer™ WeCanX®



Download WeCad™ for models and options



Features available across product family. May not apply to every model.



TCRWX2 + TCRWXPR + TCRWXS



TCRWX3 + TCRWXPC + (2) TCRWXSC



TCRWX4 + TCRWXPR + (3) TCRWXS



TCRWX5 + TCRWXPC + (4) TCRWXSC

FEATURES

- Available in SOLO™, DUO™, or TRIO™ modules
- Whelen Command® programming allows:
 - DUO and TRIO modules to operate with a steady override, such as white steady-burn
 - Full configurability of Traffic Advisor™ functionality
 - Adjustable intensity levels of cruise light control
- Dynamic Variable Intensity™ (DVI™) light patterns
- Mounts easily via slide bolt with vehicle specific brackets, universal “L” brackets, or under lightbar brackets
- SAE Class 1 certified
- Hard-coated lenses resist environmental damage from sand, sun, salt, and road chemicals
- Each control point can operate a pair of Tracers

Model	Description
TCRWX1	1-Lamp Housing and TCRL* SOLO™ Lighthouse, “L” Bracket Mounting (Two Required) Purchased Separately
TCRWX2	2-Lamp Housing and TCRL* SOLO Lighthouses, “L” Bracket Mounting (Three Required) Purchased Separately
TCRWX3	3-Lamp Housing and TCRL* SOLO Lighthouses, “L” Bracket Mounting (Four Required) Purchased Separately
TCRWX4	4-Lamp Housing and TCRL* SOLO Lighthouses, “L” Bracket Mounting (Five Required) Purchased Separately
TCRWX5	5-Lamp Housing and TCRL* SOLO Lighthouses, “L” Bracket Mounting (Six Required) or Vehicle-Specific Mounting Purchased Separately
TCRWX6	6-Lamp Housing and TCRL* SOLO Lighthouses, “L” Bracket Mounting (Seven Required) or Vehicle-Specific Mounting Purchased Separately
TCRWXP*	Primary SOLO Lighthouse Includes Lamp Driver, One Required in Position 1, for Each SOLO Tracer™ WeCanX®, Amber, Blue, White, Green or Red, No Charge When Ordered with the Appropriate Housing
TCRWXS*	Secondary SOLO Lighthouse, Amber, Blue, White, Green, and/or Red, For Use in Positions 2-6, No Charge When Ordered with the Appropriate Housing
TCRWXP#	Primary DUO™ Lighthouse Includes Lamp Driver, One Required in Position 1, for Each DUO Tracer, Red/White, Blue/White, Amber/White, Red/Blue, Red/Amber, Red/Green, Blue/Amber or Amber/Green
TCRWXS#	Secondary DUO Lighthouse, Red/White, Blue/White, Amber/White, Red/Blue, Red/Amber, Red/Green, Blue/Amber or Amber/Green, For Use in Positions 2-6
TCRWXP##	Primary TRIO™ Lighthouse Includes Lamp Driver, One Required in Position 1, for Each TRIO Tracer, Red/Blue/Amber, Red/Blue/White, Red/Amber/White, Red/Amber/Green, Red/Green/White, Blue/Amber/White, Blue/Amber/Green, Blue/Green/White, Green/Amber/White
TCRWXS##	Secondary TRIO Lighthouse, Red/Blue/Amber, Red/Blue/White, Red/Amber/White, Red/Amber/Green, Red/Green/White, Blue/Amber/White, Blue/Amber/Green, Blue/Green/White, Green/Amber/White, For Use in Positions 2-6

Consult current price list for full list of available options at whelen.com/literature.

Replace * symbol in model number with letter indicating color desired: A = Amber, B = Blue, C = White, G = Green, R = Red

Replace # in model number with interleaved color desired: D = Red/White, E = Blue/White, F = Amber/White, J = Red/Blue, K = Red/Amber, L = Red/Green, M = Blue/Amber, P = Amber/Green

Replace ## symbol in model number with letter indicating TRIO colors desired: JA = Red/Blue/Amber, JC = Red/Blue/White, KC = Red/Amber/White, KG = Red/Amber/Green,

LC = Red/Green/White, MC = Blue/Amber/White, MG = Blue/Amber/Green, NC = Blue/Green/White, PC = Green/Amber/White



DIMENSIONS

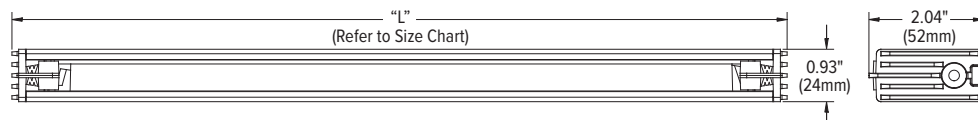

“L” Size Chart

13.80" (35.05cm) 1-lamp	26.16" (66.45cm) 2-lamp	38.53" (97.87cm) 3-lamp	50.90" (129.29cm) 4-lamp	63.26" (160.68cm) 5-lamp	75.62" (192.07cm) 6-lamp
----------------------------	----------------------------	----------------------------	-----------------------------	-----------------------------	-----------------------------

SMOKED LENS ADD-ON OPTIONS

Model	Description
TCRXXP*	Primary SOLO Lighthouse Includes Lamp Driver, One Required in Position 1, for Each SOLO Tracer™, Amber, Blue, White, Green or Red, Smoked Lens, When Ordered with the Appropriate Housing, Add (1)
TCRXXS*	Secondary SOLO Lighthouse, Amber, Blue, White, Green or Red, For Use in Positions 2-6, Smoked Lens, When Ordered with the Appropriate Housing, Add as Many as Needed
TCRXXP#	Primary DUO Lighthouse Includes Lamp Driver, One Required in Position 1, for Each DUO Tracer, Red/White, Blue/White, Amber/White, Red/Blue, Red/Amber, Red/Green, Blue/Amber, Amber/Green, with Smoked Lens, Add (1)
TCRXXS#	Secondary DUO Lighthouse, Red/White, Blue/White, Amber/White, Red/Blue, Red/Amber, Red/Green, Blue/Amber, Amber/Green, with Smoked Lens, For Use in Positions 2-6, Add as Many as Needed
TCRXXP#*	Primary TRIO Lighthouse Includes Lamp Driver, One Required in Position 1, for Each TRIO Tracer, Red/Blue/Amber, Red/Blue/White, Red/Amber/White, Blue/Amber/White, with Smoked Lens, Add (1)
TCRXXS#*	Secondary TRIO Lighthouse, Red/Blue/Amber, Red/Blue/White, Red/Amber/White, Blue/Amber/White, with Smoked Lens, Add as Many as Needed

Consult current price list for full list of available options at whelen.com/literature.

Replace * symbol in model number with letter indicating color desired: A = Amber, B = Blue, C = White, G = Green, R = Red

Replace # in model number with interleaved color desired: D = Red/White, E = Blue/White, F = Amber/White, J = Red/Blue, K = Red/Amber, L = Red/Green, M = Blue/Amber, P = Amber/Green

Replace #* symbol in model number with letter indicating TRIO colors desired: JA = Red/Blue/Amber, JC = Red/Blue/White, KC = Red/Amber/White, MC = Blue/Amber/White



ACCESSORIES FOR TRACER™ WECANX® SERIES

Model	Description
CCPKT	Core® Control Point for Use with WeCanX® Devices when NOT using CenCom Core® (For Use when not Purchasing a Lightbar)
TCRB42	2015-2018 Ram 1500 Crew Cab, 2019-2024 Ram 1500 Classic Crew Cab, and 2019-2024 RAM 2500/3500 Running Board Mounting Kit for 6-Lamp Tracer, Add as Many as Needed
TCRB44	2015-2025 Dodge Durango Running Board Mounting Kit for 5-Lamp Tracer, Add as Many as Needed
TCRB47	2015-2024 Ford F-150 PPV, 2022-2024 Ford F-150 Lightning, 2017-2025 Ford F-250/F-350 Crew Cab, 2018-2024 Ford F450/F550, 2018-2024 Ford F600, 2018-2024 and Ford Expedition SSV, Running Board Mounting Kit for 6-Lamp Tracer, Add as Many as Needed
TCRB49	2019-2024 Chevy Silverado 1500 Crew Cab, 2023-2025 Chevy Silverado 2500/3500 HD Running Board Mounting Kit for 6-Lamp Tracer, Add as Many as Needed
TCRB50	2020-2025 Ford Police Interceptor Utility Running Board Mounting Kit for 5 or 6-Lamp Tracer, Add as Many as Needed
TCRB54A	2021-2025 Chevy Tahoe PPV/SSV Running Board Mounting Kit for 5-Lamp or 6-Lamp, Add as Many as Needed
TCRB54S	2021-2025 Chevy Suburban Running Board Mounting Kit for 6-Lamp Tracer, Add as Many as Needed
TCRB56	2021-2022 Tesla Model Y Running Board Mounting Kit for 5-Lamp Tracer, Add as Many as Needed
TCRB57	2021-2024 Ford Mach-E Running Board Mounting Kit for 5-Lamp Tracer, Add as Many as Needed
TCRLBKT	1 "L" Bracket and Hardware, See Tracer Description for Quantity Required
TCRLBKT1	1 Single Mounting Bracket and Hardware for Front or Rear Mounting of the Tracer Series Under a Lightbar, See Tracer Description for Quantity Required, NOTE: Tracer Length Will Depend on Lightbar Length and Placement of Mounting Feet, Not for Use with Low-Profile Mounting Feet
TCRLBKT2	1 Dual Mounting Bracket and Hardware for Front and Rear Mounting of the Tracer Series Under a Lightbar, See Tracer Description for Quantity Required, NOTE: Tracer Length Will Depend on Lightbar Length and Placement of Mounting Feet, Not for Use with Low-Profile Mounting Feet



Scan the QR code or visit vehicleoutfitter.whelen.com for a complete list of vehicle fitment options.



⚠ WARNING: This product may contain chemicals known to the State of California to cause cancer and birth defects or other reproductive harm. For more information, visit whelen.com/regulatory.

MINI LIGHTBARS

Pioneer Micro™

Mini Freedom® IV Series

M6 Series

M6 Series

28

WHELEN
MANUFACTURED IN AMERICA

 **WARNING:** This product may contain chemicals known to the State of California to cause cancer and birth defects or other reproductive harm. For more information, visit whelen.com/regulatory.

Mini Freedom® IV Series ISOLO™ DUO™

DYAD: 10YR 5YR 12 NFPA 1900 CONTRIBUTOR SC SAE CLASS 1 HARD COAT SCAN LOCK DVI ENABLED WECAN X

ROTA-BEAM: 5YR 12 NFPA 1900 CONTRIBUTOR SAE CLASS 1 HARD COAT SCAN LOCK ROTA-BEAM

Features available across product family. May not apply to every model.

Download WeCad™ for models and options



R4MRRRP



R4BCRCP

FEATURES

- SAE Class 1 Certified
- Single-color corner modules available in Amber, Blue, White, Green or Red
- Hard-coated lenses resist environmental damage from sand, sun, salt, and road chemicals
- Clear outer domes with Clear dividers

- Extruded aluminum platform for long-life dependability
- Magnetic mount includes cigar plug with On/Off switch with LED "On" indicator, and Scan-Lock pattern control switch
- Includes 15' (4.57m) cable and permanent mount

MINI FREEDOM IV

- Linear Super-LED®
- 67 Scan-Lock™ flash patterns

MINI FREEDOM IV ROTA-BEAM

- Rotating Super-LED technology
- 10 Scan-Lock flash patterns

Model	Description
Standard Current Model	
F4M****P	Permanent Mount, Four Corners, Amber, Blue, White, Green or Red
F4M****M	Magnetic Mount, Four Corners, Amber, Blue, White, Green or Red
F4B****P	Permanent Mount, Four Corners and Center Section, Amber, Blue, White, Green or Red
F4M*O*OF	Permanent Mount, Two Front Facing Corners, Amber, Blue, White, Green or Red
F4G*O*OF	Permanent Mount, Two Front Facing Corners, Pre-Wired for Miovision Center Mounted Emitter, Amber, White or Red
Rota-Beam Model	
R4B****P	Permanent Mount, Four Rotating Super-LED Corner Modules
R4B*O*OP	Permanent Mount, Two Front Facing Rotating Super-LED Corner Modules
DYAD Model	
K4M****P	WeCanX®, Permanent Mount, Four Corners DYAD Amber, Blue, White, or Red
K4B****P	WeCanX, Permanent Mount, Four Corners and center section, DYAD Amber, Blue, White, or Red
DUO™ Model	
K2M####	WeCanX, Permanent Mount, Four Corners DUO Amber, Blue, White, or Red
K42B####	WeCanX, Permanent Mount, Four Corners and Center Section DUO™ Amber, Blue, White, Green, or Red
NFPA Model	
F4NMINI	Two Mini Freedom IV, Each Lightbar Consists of Two Red Front Corners, Two Front Center White and One Red End, Sold in Pairs
K42MINI	Two 21.5" Mini Freedom IV, Each Lightbar Consists of Two Red Front Corners, Two Front, Center White and One Red End, Sold in Pairs

Replace * symbol in model number with letter indicating color desired: A = Amber, B = Blue, C = White, G = Green, R = Red
 Replace # symbol in model number with letters indicating color combination desired:
 D = Red/White, E = Blue/White, F = Amber/White, J = Red/Blue, K = Red/Amber, M = Blue/Amber, P = Amber/Green



DIMENSIONS

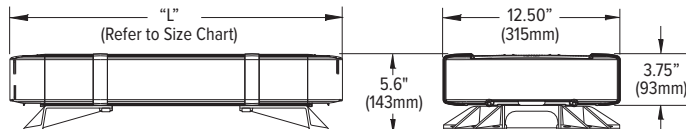

"L" Size Chart

21.50" (54.61cm)	23.25" (59.16cm)
---------------------	---------------------

OPTIONS



6-LED Take-Down

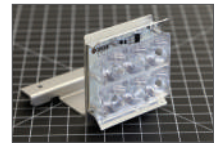

6-LED Alley Light



Long Lighthead



Filter



Miovision Opticom™ Emitter 795H

⚠ WARNING: This product may contain chemicals known to the State of California to cause cancer and birth defects or other reproductive harm. For more information, visit whelen.com/regulatory.

Micro Freedom® Series



Features available across product family. May not apply to every model.



MCFLED2R

FEATURES

- Heavy-duty extruded aluminum frame for tailboard mounting
- Available with Color LEDs and Clear lenses
- 240° light output with built-in flasher

- Available as stud mount
- Hard-coated lenses resist environmental damage from sand, sun, salt, and road chemicals
- Dynamic Variable Intensity™ (DVI™) light patterns

Model	Description
MCFLED2*	Micro Freedom, Amber, Blue, White, and/or Red

Consult current price list for full list of available options at whelen.com/literature.
 Replace * symbol in model number with letter indicating color desired:
 A = Amber, B = Blue, C = White, R = Red
 To order Clear lenses add corresponding number to the end of model number
 1 = A, 2 = B, 5 = R



DIMENSIONS

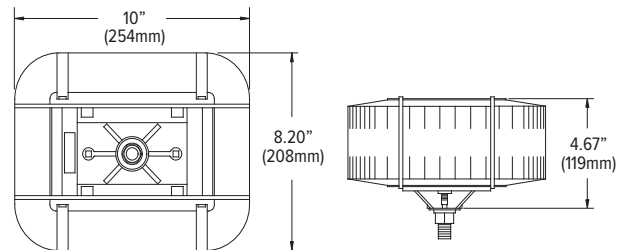

Mini Edge® 9X Series



Features available across product family. May not apply to every model.

Download WeCad™ for models and options



9X5DDDD

FEATURES

- Powered by WeCanX® technology
- DUO™ Linear12™ LED and DUO Linear6™ LED Warning & Scene Take-Down/Alley
- Hard-coated lenses resist environmental damage from sand, sun, salt, and road chemicals
- Photocell included

- Passenger side cable exit
- Advanced Thermal Design improves LED performance during extended operation
- Molded polycarbonate Black top repels hail and protects against other environmental damages
- Standard mounting feet

Model	Description
9XS5####	25", Short Edge 9X Series, 4 Two-Color Amber, Blue, White, Green, and/or Red
9XT5####	25", Tall Edge 9X Series, 4 Two-Color Amber, Blue, White, Green, and/or Red

Replace # in model number with interleaved color desired: D = Red/White, E = Blue/White, F = Amber/White, J = Red/Blue, K = Red/Amber, M = Blue/Amber, P = Amber/Green



DIMENSIONS

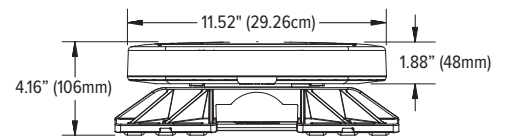

9XS

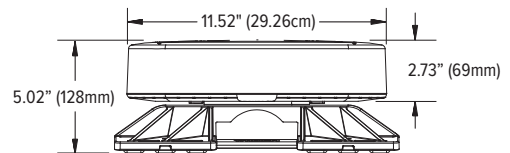

9XT

LIGHTHEADS



M6 Series

 **WARNING:** This product may contain chemicals known to the State of California to cause cancer and birth defects or other reproductive harm. For more information, visit whelen.com/regulatory.

WHELEN
MANUFACTURED IN AMERICA

M9 Series



Features available across product family. May not apply to every model.



FEATURES

- SAE Class 1 Certified
- Available in combination warning/scene light
- M9 V-Series™ models feature 2-in-1 combination warning and scene lighting
- Clear or Color lenses available
- Available in steady-burn or with an internal flasher
- Hard-coated lenses resist environmental damage from sand, sun, salt, and road chemicals
- Mounts to surface via two screws for easy installation
- A variety of mounting brackets and optional Chrome or Black flanges are available
- Dynamic Variable Intensity™ (DVI™) light patterns
- E Block™ technology prevents air and moisture from entering lighthouse
- E Block technology in DUO™ and Signaling variants only
- KKK-A-1822F Contributor when apparatus is appropriately configured as listed in the applicable standard

Model	Description
M9*	Internal Flasher, Color Lens, Amber, Blue, White, Green or Red
M9*C	Internal Flasher, Clear Lens, Amber, Blue, Green or Red
M9#	Split-Color, Internal Flasher, Clear Lens, Red/White, Blue/White, Amber/White, Red/Blue, Red/Amber or Blue/Amber
M9D#	DUO™, Internal Flasher, Clear Lens, Red/White, Blue/White, Amber/White, Red/Blue, Red/Amber, Blue/Amber, or Amber/Green
M9*S	Steady-Burn, Color Lens, Amber, Blue, White or Red
M9*CS	Steady-Burn, Clear Lens, Amber, Blue or Red
M9*CZ	Combination Warning/Scene Light, Internal Flasher, Clear Lens, Amber, Blue, White or Red
M9JCZ	DUO, Combination Warning/Scene Light, Internal Flasher, Clear Lens, Red/Blue
M9V2*	V-Series, Combination 180° Warning/Scene Light, Internal Flasher, Color Warning Lens and Clear Illumination Lens, Amber, Blue, White or Red
M9V2*C	V-Series, Combination 180° Warning/Scene Light, Internal Flasher, Clear Lens, Amber, Blue or Red

Consult current price list for full list of available options at whelen.com/literature

Replace * symbol in model number with letter indicating color desired: A = Amber, B = Blue, C = White, G = Green, R = Red

Replace # in model number with interleaved color desired: D = Red/White, E = Blue/White, F = Amber/White, H = Green/White, J = Red/Blue, K = Red/Amber, M = Blue/Amber, P = Amber/Green



DIMENSIONS

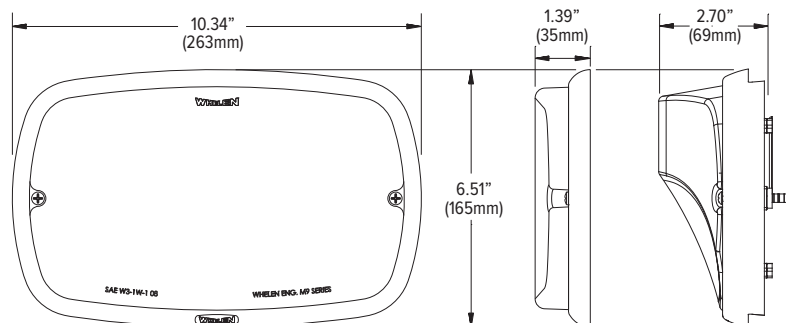

M6 & M7 Series



Features available across product family. May not apply to every model.



M6R



M6V2R



M7R

FEATURES

- SAE Class 1 Certified
- Single- or split-color models available
- Combination warning/scene light models available
- Clear or Color lenses available
- Available in steady-burn or with an internal flasher
- M6 V-Series™ models feature 2-in-1 combination warning and perimeter lighting
- Mounts to surface via two screws for easy installation
- Dynamic Variable Intensity™ (DVI™) light patterns
- Hard-coated lenses resist environmental damage from sand, sun, salt, and road chemicals
- A variety of mounting brackets and optional Chrome or Black flanges are available
- E Block™ technology prevents air and moisture from entering lighthouse
- E Block technology in DUO™ and Signaling variants only
- KKK-A-1822F Contributor when apparatus is appropriately configured as listed in the applicable standard

Model	M6 Series Description
M6*	Internal Flasher, Color Lens, Amber, Blue, White or Red
M6*C	Internal Flasher, Clear Lens, Amber, Blue, Green or Red
M6#	Split-Color, Internal Flasher, Clear Lens, Red/White, Blue/White, Amber/White, Green/White, Red/Blue, Red/Amber, Red/Green or Blue/Amber
M6D#	DUO™, Internal Flasher, Clear Lens, Red/White, Blue/White, Amber/White, Green/White, Red/Blue, Red/Amber, Red/Green, Red/Amber, Blue/Amber or Amber/Green
M6*S	Steady-Burn, Color Lens, Amber, Blue, White or Red
M6*CS	Steady-Burn, Clear Lens, Amber, Blue, Green or Red
M6V2*	V-Series, Combination 180° Warning/Scene Light, Internal Flasher, Color Warning Lens and Clear Illumination Lens, Amber, Blue, White or Red
M6V2*C	V-Series, Combination 180° Warning/Scene Light, Internal Flasher, Clear Lens, Amber, Blue or Red
Model	M7 Series Description
M7*	Internal Flasher, Color Lens, Amber, Blue, White, Green or Red
M7*C	Internal Flasher, Clear Lens, Amber, Blue, Green or Red
M7#	Split-Color, Internal Flasher, Clear Lens, Red/White, Blue/White, Amber/White, Red/Blue or Blue/Amber
M7D#	DUO, Internal Flasher, Clear Lens, Red/White, Blue/White, Amber/White, Red/Blue, Red/Green, Blue/Amber or Amber/Green
M7*S	Steady-Burn, Color Lens, Amber, Blue, White or Red
M7*CS	Steady-Burn, Clear Lens, Amber, Blue, Green or Red

Consult current price list for full list of available options at whelen.com/literature

Replace * symbol in model number with letter indicating color desired: A = Amber, B = Blue, C = White, G = Green, R = Red

Replace # in model number with interleaved color desired: D = Red/White, E = Blue/White, F = Amber/White, H = Green/White, J = Red/Blue, K = Red/Amber, L = Red/Green, M = Blue/Amber



DIMENSIONS

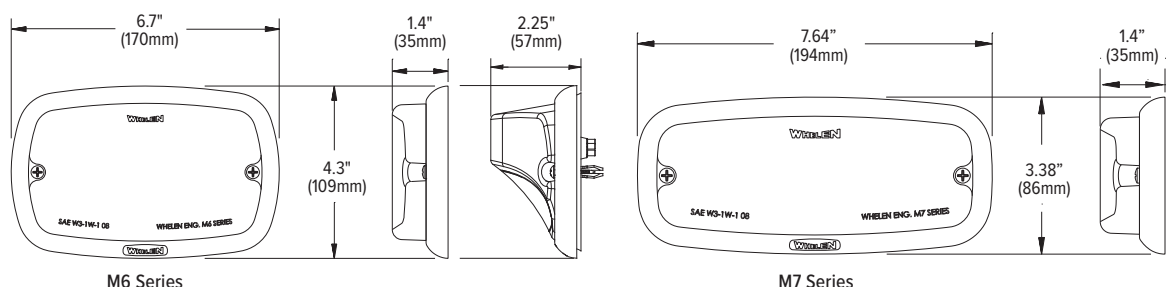

⚠ WARNING: This product may contain chemicals known to the State of California to cause cancer and birth defects or other reproductive harm. For more information, visit whelen.com/regulatory.

M2 & M4 Series



Features available across product family. May not apply to every model.



ML2R



M2R



M4R



M4V2R

FEATURES

- Combination warning/scene light models available
- Hard-coated lenses resist environmental damage from sand, sun, salt, and road chemicals
- Mounts to surface via two screws for easy installation
- Clear or Color lenses available
- Available in steady-burn or with an internal flasher
- Dynamic Variable Intensity™ (DVI™) light patterns
- E Block™ technology prevents air and moisture from entering lighthouse
- E Block technology in DUO and Signaling variants only
- KKK-A-1822F Contributor when apparatus is appropriately configured as listed in the applicable standard

Model	M2 Series Description
M2*	SOLO™, TIR™ Super-LED®, Internal Flasher, Color Lens, Amber, Blue, White, Green or Red
M2*C	SOLO, TIR Super-LED, Internal Flasher, Clear Lens, Amber, Blue, Green or Red
M2#	Split-Color, TIR Super-LED, Internal Flasher, Clear Lens, Red/White, Blue/White, Amber/White, Green/White, Red/Blue Red/Amber or Blue/Amber
ML2*	SOLO Linear-LED®, Internal Flasher, Color Lens, Amber, Blue, White, Green or Red
ML2D#	DUO™ Linear-LED, Internal Flasher, Clear Lens, Red/White, Blue/White, Amber/White, Green/White, Red/Blue, Red/Amber Red/Green or Blue/Amber
M2W*	SOLO, TIR Super-LED, Wide-Angle Warning Light, Internal Flasher, Color Lens, Amber, Blue, White, Green or Red
M2W*C	SOLO, TIR Super-LED, Wide-Angle Warning Light, Internal Flasher, Clear Lens, Amber, Blue, Green or Red
M2W#	DUO, TIR Super-LED, Wide-Angle Warning Light, Split-Color, Internal Flasher, Clear Lens, Red/White, Blue/White, Amber/White, Red/Blue, Red/Amber or Blue/Amber
Model	M4 Series Description
M4*	Internal Flasher, Color Lens, Amber, Blue, White, Green or Red
M4*C	Internal Flasher, Color Lens, Amber, Blue, Green or Red
M4#	Split-Color, Internal Flasher, Clear Lens, Red/White, Blue/White, Amber/White, Red/Blue Red/Amber, Red/Green or Blue/Amber
M4D#	DUO, Internal Flasher, Clear Lens, Red/White, Blue/White, Amber/White, Green/White, Red/Blue, Red/Amber Red/Green, Blue/Amber, Blue/Green, Amber/Green
M4*S	Steady-Burn, Color Lens, Amber, Blue, White or Red
M4*CS	Steady-Burn, Color Lens, Amber, Blue or Red
M4DW*	Combination Driving/Warning Light, Internal Flasher, Clear Lens, Amber, Blue or Red
M4DWJ	Combination Driving/Warning Light, Internal Flasher, Clear Lens, Red Over Blue
M4V2*	V-Series™, Combination 180° Warning/Scene Light, Internal Flasher, Color Lens, Amber, Blue, White or Red Warning

Consult current price list for full list of available options at whelen.com/literature

Replace * symbol in model number with letter indicating color desired: A = Amber, B = Blue, C = White, G = Green, R = Red

Replace # in model number with interleaved color desired: D = Red/White, E = Blue/White, F = Amber/White, H = Green/White,

J = Red/Blue, K = Red/Amber, L = Red/Green, M = Blue/Amber, N = Blue/Green, P = Amber/Green



DIMENSIONS

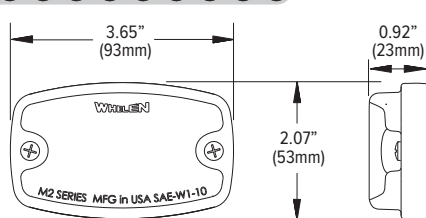

M2 Series

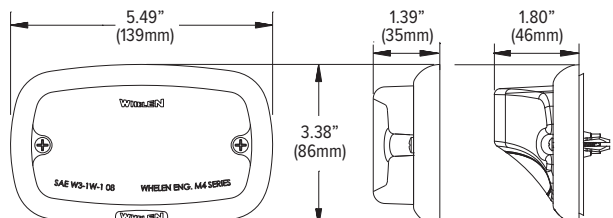

M4 Series

M4 V-Series

900 Series



Features available across product family. May not apply to every model.

FEATURES

- Single or split-color models available
- Mounts to surface via four screws
- 6" (15.24cm) pigtail included
- Clear or Color lenses available
- See page 73 for scene light options
- KKK-A-1822F Contributor when apparatus is appropriately configured as listed in the applicable standard

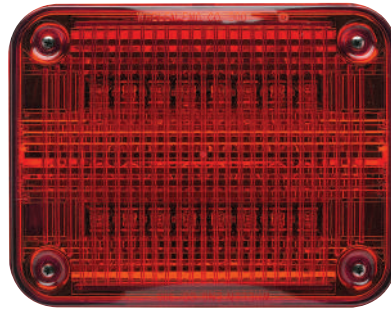

90RR5FRR

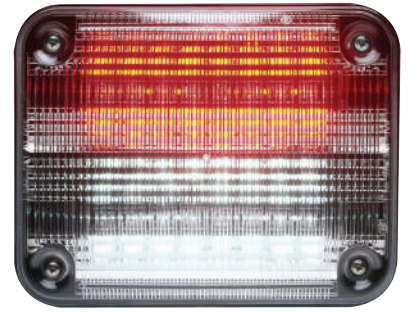

90RC5FCR

Model	Description
90**5S*R	Super-LED®, Amber, Blue, White, Green or Red, Requires LED Flasher Purchased Separately
90**5F*R	Super-LED, Includes Internal Flasher, Amber, Blue, White or Red
90**5FCR	Linear Split-Color Super LED, Internal Flasher, Red/White, Blue/White, Amber/White, Green/White, Red/Blue, Red/Amber, Amber/Green

Consult current price list for full list of available options at whelen.com/literature

Replace * symbol in model number with letter indicating color desired:

A = Amber, B = Blue, C = White, G = Green, R = Red

Replace ** symbol in model number with letters indicating split-color desired: RC = Red/White, BC = Blue/White,

AC = Amber/White, GC = Green/White, BR = Red/Blue, RA = Red/Amber, AG = Amber/Green



DIMENSIONS

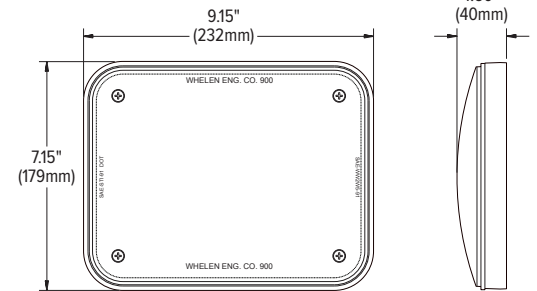

700 Series



Features available across product family. May not apply to every model.

FEATURES

- Single or split-color models available
- Mounts to surface via four screws
- 6" (15.24cm) pigtail included
- Clear or Color lenses available
- Hard-coated lenses resist environmental damage from sand, sun, salt, and road chemicals

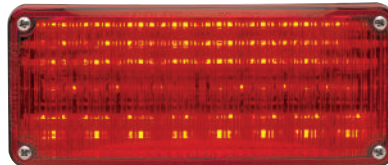

70R02FRR

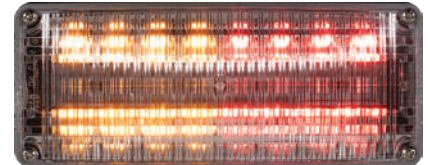

70RA6FCR

Model	Description
70*02S*R	Super-LED®, Amber, Blue, White, Green or Red, Requires LED Flasher Purchased Separately
70*02F*R	Super-LED, Includes Internal Flasher, Amber, Blue, White, Green or Red
70**6FCR	Linear Split-Color, Red/White, Red/Blue, Red/Amber

Consult current price list for full list of available options at whelen.com/literature

Replace * symbol in model number with letter indicating color desired:

A = Amber, B = Blue, C = White, G = Green, R = Red

Replace ** symbol in model number with letters indicating split-color desired:

RC = Red/White, BR = Red/Blue, RA = Red/Amber



DIMENSIONS

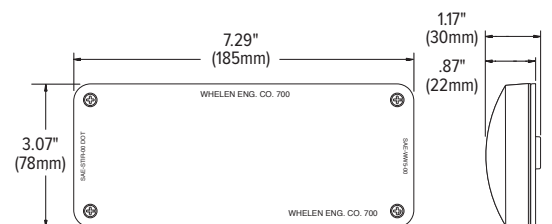

⚠ WARNING: This product may contain chemicals known to the State of California to cause cancer and birth defects or other reproductive harm. For more information, visit whelen.com/regulatory.

600 Series



Features available across product family. May not apply to every model.

FEATURES

- Linear Super-LED® or Rota-Beam™ models available
- Clear or Color lenses available
- Available in steady-burn or with an internal flasher
- See page 73 for scene light options
- KKK-A-1822F Contributor when apparatus is appropriately configured as listed in the applicable standard



Model	Description
6RB*	Rota-Beam Oscillating Super-LED, Amber, Blue, White, Green or Red, Color Lens
6RB*C	Rota-Beam Oscillating Super-LED, Amber, Blue, White, Green or Red, Clear Lens
60*02S*R	Linear Super-LED, Amber, Blue, White, Green or Red
60*02F*R	Linear Super-LED, Internal Flasher, Amber, Blue, White, Green or Red
60**6FCR	Linear Split-Color Super LED, Internal Flasher, Red/White, Blue/White, Amber/White, Red/Blue, Red/Amber

Consult current price list for full list of available options at whelen.com/literature

Replace * symbol in model number with letter indicating color desired: A = Amber, B = Blue, C = White, G = Green, R = Red

Replace ** symbol in model number with letters indicating split-color desired: RC = Red/White, BC = Blue/White,

AC = Amber/White, BR = Red/Blue, RA = Red/Amber



DIMENSIONS

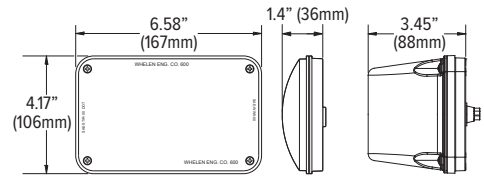

600 Series Linear Super-LED

600 Series Rota-Beam Oscillating Super-LED

500 Series



Features available across product family. May not apply to every model.

FEATURES

- Available with Linear Super-LED or TIR6™ optics
- Clear or Color lenses available
- Hard-coated lenses resist environmental damage from sand, sun, salt, and road chemicals
- Lighthoods require mounting flange
- KKK-A-1822F Contributor when apparatus is appropriately configured as listed in the applicable standard



Model	Description
50*02Z*R	Linear Super-LED, Horizontal Mount, Warning, Amber, Blue, White, Green or Red
50**2ZCR	Linear Super-LED, Horizontal Mount, Warning, Split-Color Red/White, Blue/White, Amber/White, Red/Blue, Red/Amber, Blue/Amber, Amber/Green
5V*02Z*R	Linear Super-LED, Vertical Mount, Warning, White or Red
50*03Z*R	TIR6, Super-LED Warning, Amber, Blue, White, Green or Red
50**3ZCR	TIR6, Super-LED, Warning, Split-Color Red/White, Blue/White, Amber/White, Red/Blue, Red/Amber, Blue/Amber
5V1*	V-Series™ and TIR™ Super-LED Warning, Amber, Blue, White, Green or Red
5V3*	V-Series Super-LED Warning, Alley/Flood and Puddle Light, Amber, Blue, White or Red with White Illumination

Consult current price list for full list of available options at whelen.com/literature

Replace * symbol in model number with letter indicating color desired: A = Amber, B = Blue, C = White, G = Green, R = Red

Replace ** symbol in model number with letters indicating split-colors desired: RC = Red/White, BC = Blue/White,

AC = Amber/White, RB = Red/Blue, AR = Red/Amber, AB = Blue/Amber, AG = Amber/Green



DIMENSIONS

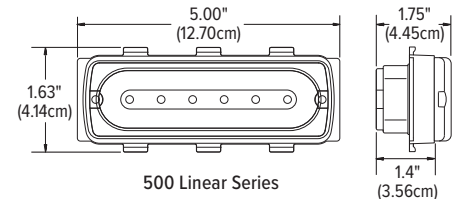

500 Linear Series

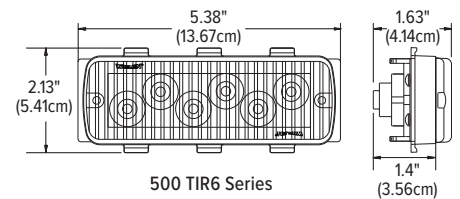

500 TIR6 Series

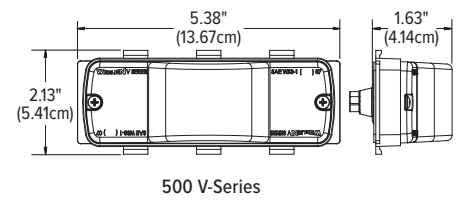

500 V-Series

400 Series Plus



Features available across product family. May not apply to every model.

FEATURES

- SAE Class 1 and CA Title 13 (Amber) apply to horizontal and vertical lights
- Linear-LED® design produces highly intense light that has superior wide-angle visibility
- Single-color LED SOLO™ or two-color interleaved DUO™ technology
- DUO models include White override option when Color 2 is White
- Connect and flash multiple Whelen devices together or in alternating patterns with Sync
- Built-in flasher included with SmartLED® models



404A0SAR

- IP67 rated
- Patented E Block™ technology prevents air and moisture from entering lighthouse
- Conformal coated electronics for moisture and vibration resistance
- Same mounting footprint and accessories as the original 400 Series
- KKK-A-1822F Contributor when apparatus is appropriately configured as listed in the applicable standard

Model	Description
404*0S*R	SOLO Steady, Amber, Blue, White, Green or Red, Clear or Color Lens
404#0SCR	DUO Steady, Red/White, Blue/White, Amber/White, Green/White, Red/Blue, Red/Amber, Blue/Amber, Amber/Green, Clear Lens
404*0Z*R	SOLO SmartLED, Amber, Blue, White, Green or Red, Clear or Color Lens
404#0ZCR	DUO SmartLED, Red/White, Blue/White, Amber/White, Green/White, Red/Blue, Red/Amber, Blue/Amber, Blue/Green, Amber/Green, Clear Lens

DIMENSIONS

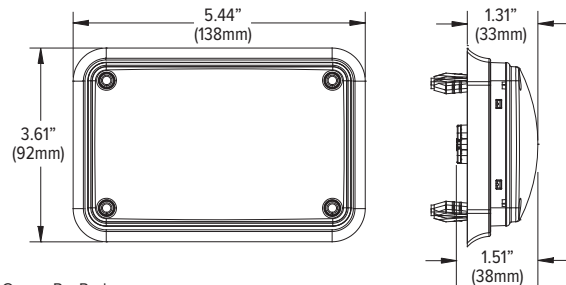

*Replace symbol in model number with letter indicating desired color: A = Amber, B = Blue, C = White, G = Green, R = Red
 # Replace symbol in model number with letter indicating desired DUO colors: D = Red/White, E = Blue/White, F = Amber/White, J = Red/Blue, K = Red/Amber, M = Blue/Amber, N = Blue/Green, P = Amber/Green



400 Series



Features available across product family. May not apply to every model.

FEATURES

- Linear Super-LED® available in single or dual level warning
- Hard-coated lenses resist environmental damage from sand, sun, salt, and road chemicals
- Clear or Color lenses available
- KKK-A-1822F Contributor when apparatus is appropriately configured as listed in the applicable standard



40R02ZCR

40AR5SCR

4V3R

Model	Description
40**5SCR	Dual Level Linear Super-LED, Amber, Blue, White, Green or Red
40*0Z2*R	Single Level Linear Super-LED, Amber, Blue, White, Green or Red
4V3*	V-Series™, Combination 180° Warning, Alley and Puddle Light, Amber, Blue, White or Red Warning

Consult current price list for full list of available options at whelen.com/literature
 Replace * symbol in model number with letter indicating color desired:
 A = Amber, B = Blue, C = White, G = Green, R = Red



DIMENSIONS

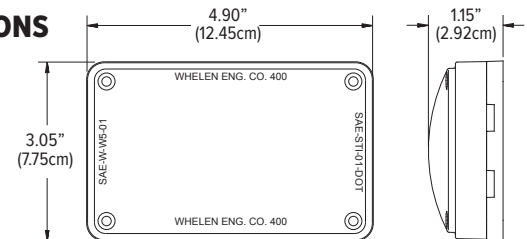

400 Series Single and Dual Level

⚠ WARNING: This product may contain chemicals known to the State of California to cause cancer and birth defects or other reproductive harm. For more information, visit whelen.com/regulatory.

Mega T-Series™



Features available across product family. May not apply to every model.



PSJC3FCR

FEATURES

- SAE Class 1 Certified
- Linear Super-LED® optics
- SOLO™: 25 Scan-Lock™ flash patterns including steady-burn
- DUO™: 67 Scan-Lock flash patterns including steady-burn
- TRIO™: 73 Scan-Lock flash patterns including steady-burn
- Steady-Lock® technology sets lightheads to steady automatically when used with a Core® control system
- Hard-coated lenses resist environmental damage from sand, sun, salt, and road chemicals
- Surface mount via 2 screws for easy installation
- E Block™ technology prevents air and moisture from entering lighthead
- TRIO: Dynamic Variable Intensity™ (DVI™)

Model	Description
PS*01FCR	SOLO, Amber, Blue, White, Green, or Red, Clear Lens
PS#02FCR	DUO, Red/White, Blue/White, Amber/White, Red/Blue, Red/Amber, or Blue/Amber, Clear Lens
PS#*3FCR	TRIO, Red/Blue/Amber, Red/Blue/White, Red/Blue/Green, Red/Amber/White, Red/Amber/Green, Red/Green/White, Blue/Amber/White, Blue/Amber/Green, Blue/Green/White or Amber/Green/White, Clear Lens

Consult current price list for full list of available options at whelen.com/literature

Replace * symbol in model number with letter indicating color desired: A = Amber, B = Blue, C = White, G = Green, R = Red

Replace # symbol in model number with letter indicating colors desired: D = Red/White, E = Blue/White, F = Amber/White, J = Red/Blue, K = Red/Amber, M = Blue/Amber, N = Blue/Green and P = Amber/Green

Replace #* symbol in model number with letters indicating colors desired: JA = Red/Blue/Amber, JC = Red/Blue/White, JG = Red/Blue/Green, KC = Red/Amber/White, KG = Red/Amber/Green, LC = Red/Green/White, MC = Blue/Amber/White, MG = Blue/Amber/Green, NC = Blue/Green/White, PC = Amber/Green/White



DIMENSIONS

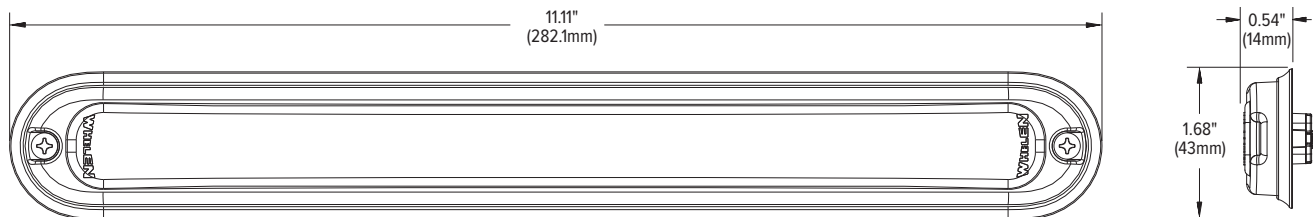

T-Series™



Features available across product family. May not apply to every model.



TSS0D



TSS0F

FEATURES

- SAE Class 1 Certified
- Linear Super-LED® optics
- SOLO™, DUO™ and TRIO™ models available
- Hard-coated lenses resist environmental damage from sand, sun, salt, and road chemicals
- Smoked lenses available
- Easily mounts to the surface via two screws or two studs
- Includes Black flange
- E Block™ technology prevents air and moisture from entering lighthead

Model	Description
TSSO*	Surface Mount, SOLO, Amber, Blue, White, Green or Red, Clear Lens
TSSP*	Surface Mount, SOLO, Amber, Blue, White, Green or Red, Low Power, Clear Lens
TSSO*X	Surface Mount, SOLO, Amber, Blue, White, Green or Red, Smoked Lens
TSSP*X	Surface Mount, SOLO, Amber, Blue, White, Green or Red, Low Power, Smoked Lens
TSSO#	Surface Mount, DUO, Red/White, Blue/White, Amber/White, Green/White, Red/Blue, Red/Amber, Red/Green, Blue/Amber, Blue/Green or Amber/Green Only, Clear Lens
TSSP#	Surface Mount, DUO, Red/White, Blue/White, Amber/White, Green/White, Red/Blue, Red/Amber, Red/Green, Blue/Amber, Blue/Green or Amber/Green Only, Low Power, Clear Lens
TSSO#X	Surface Mount, DUO, Red/White, Blue/White, Amber/White, Green/White, Red/Blue, Red/Amber, Red/Green, Blue/Amber, Blue/Green or Amber/Green, Smoked Lens
TSSP#X	Surface Mount, DUO, Red/White, Blue/White, Amber/White, Green/White, Red/Blue, Red/Amber, Red/Green, Blue/Amber, Blue/Green or Amber/Green, Low Power, Smoked Lens
TSSO##	Surface Mount, TRIO Red/Blue/Amber, Red/Blue/White, Red/Blue/Green, Red/Amber/White, Red/Amber/Green, Red/Green/White, Green/Amber/White, Blue/Amber/Green, Blue/Green/White, Blue/Amber/White, Clear Lens
TSSO##X	Surface Mount, TRIO Red/Blue/Amber, Red/Blue/White, Red/Blue/Green, Red/Amber/White, Red/Amber/Green, Red/Green/White, Green/Amber/White, Blue/Amber/Green, Blue/Green/White, Blue/Amber/White, Smoked Lens
TSTO*	Stud Mount, Amber, Blue, White, Green or Red, Clear Lens
TSTP*	Stud Mount, Amber, Blue, White, Green or Red, Low Power, Clear Lens
TSTO*X	Stud Mount, Amber, Blue, White, Green or Red, Smoked Lens
TSTP*X	Stud Mount, Amber, Blue, White, Green or Red, Low Power, Smoked Lens
TSTO#	Stud Mount, DUO, Red/White, Blue/White, Amber/White, Green/White, Red/Blue, Red/Amber, Red/Green, Blue/Amber, Blue/Green or Amber/Green, Clear Lens
TSTP#	Stud Mount, DUO, Red/White, Blue/White, Amber/White, Green/White, Red/Blue, Red/Amber, Red/Green, Blue/Amber, Blue/Green or Amber/Green, Low Power, Clear Lens
TSTO#X	Stud Mount, DUO, Red/White, Blue/White, Amber/White, Green/White, Red/Blue, Red/Amber, Red/Green, Blue/Amber, Blue/Green or Amber/Green, Smoked Lens
TSTP#X	Stud Mount, DUO, Red/White, Blue/White, Amber/White, Green/White, Red/Blue, Red/Amber, Red/Green, Blue/Amber, Blue/Green or Amber/Green, Low Power, Smoked Lens
TSTO##	Stud Mount, TRIO Red/Blue/Amber, Red/Blue/White, Red/Blue/Green, Red/Amber/White, Red/Amber/Green, Red/Green/White, Green/Amber/White, Blue/Amber/Green, Blue/Green/White, Blue/Amber/White, Clear Lens
TSTO##X	Stud Mount, TRIO Red/Blue/Amber, Red/Blue/White, Red/Blue/Green, Red/Amber/White, Red/Amber/Green, Red/Green/White, Green/Amber/White, Blue/Amber/Green, Blue/Green/White, Blue/Amber/White, Smoked Lens

Consult current price list for full list of available options at whelen.com/literature
 Replace * symbol in model number with letter indicating color desired:
 A = Amber, B = Blue, C = White, G = Green, R = Red
 Replace # symbol in model number with letter indicating DUO colors desired:
 D = Red/White, E = Blue/White, F = Amber/White, H = Green/White, J = Red/Blue,
 K = Red/Amber, L = Red/Green, M = Blue/Amber, N = Blue/Green, P = Amber/Green
 Replace ## symbol in model number with letter indicating TRIO colors desired:
 JA = Red/Blue/Amber, JC = Red/Blue/White, JG = Red/Blue/Green,
 KC = Red/Amber/White, KG = Red/Amber/Green, LC = Red/Green/White,
 MC = Blue/Amber/White, MG = Blue/Amber/Green, NC = Blue/Green/White,
 PC = Green/Amber/White

DIMENSIONS

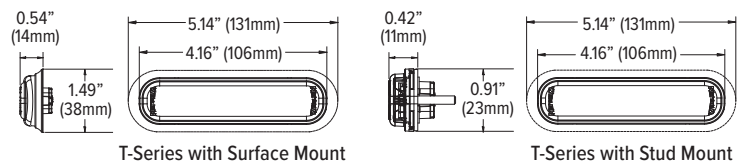

⚠ WARNING: This product may contain chemicals known to the State of California to cause cancer and birth defects or other reproductive harm. For more information, visit whelen.com/regulatory.

Mini T-Series™



Features available across product family. May not apply to every model.



TMS0D



TMS0F

FEATURES

- SAE Class 1 Certified
- Linear Super-LED® optics
- SOLO™ and DUO™ models available
- Hard-coated lenses resist environmental damage from sand, sun, salt, and road chemicals
- Easily mounts to the surface via two screws or two studs
- Includes Black flange
- Smoked lenses available
- E Block™ technology prevents air and moisture from entering lighthouse

Model	Description
TMS0*	Surface Mount, SOLO, Amber, Blue, White, Green or Red, Clear Lens
TMSP*	Surface Mount, SOLO, Amber, Blue, White, Green or Red, Low Power, Clear Lens
TMS0*X	Surface Mount, SOLO, Amber, Blue, White, Green or Red, Smoked Lens
TMSP*X	Surface Mount, SOLO, Amber, Blue, White or Red, Low Power, Smoked Lens
TMS0#	Surface Mount, DUO, Red/White, Blue/White, Amber/White, Green/White, Red/Blue, Red/Amber, Red/Green, Blue/Amber, Blue/Green or Amber/Green Only, Clear Lens
TMSP#	Surface Mount, DUO, Red/White, Blue/White, Amber/White, Green/White, Red/Blue, Red/Amber, Red/Green, Blue/Amber, Blue/Green or Amber/Green Only, Low Power, Clear Lens
TMS0#X	Surface Mount, DUO, Red/White, Blue/White, Amber/White, Green/White, Red/Blue, Red/Amber, Red/Green, Blue/Amber, Blue/Green or Amber/Green, Smoked Lens
TMSP#X	Surface Mount, DUO, Red/White, Blue/White, Amber/White, Green/White, Red/Blue, Red/Amber, Red/Green, Blue/Amber, Blue/Green or Amber/Green, Low Power, Smoked Lens
TMS0#*	Surface Mount, TRIO™ Red/Blue/Amber, Red/Blue/White, Red/Blue/Green, Red/Amber/White, Red/Amber/Green, Red/Green/White, Green/Amber/White, Blue/Amber/Green, Blue/Green/White, Blue/Amber/White, Clear Lens
TMS0#*X	Surface Mount, TRIO Red/Blue/Amber, Red/Blue/White, Red/Blue/Green, Red/Amber/White, Red/Amber/Green, Red/Green/White, Green/Amber/White, Blue/Amber/Green, Blue/Green/White, Blue/Amber/White, Smoked Lens
TMT0*	Stud Mount, Amber, Blue, White, Green or Red, Clear Lens
TMT0*	Stud Mount, Amber, Blue, White, Green or Red, Low Power, Clear Lens
TMT0*X	Stud Mount, Amber, Blue, White, Green or Red, Smoked Lens
TMT0*X	Stud Mount, Amber, Blue, White, Green or Red, Low Power, Smoked Lens
TMT0#	Stud Mount, DUO, Red/White, Blue/White, Amber/White, Green/White, Red/Blue, Red/Amber, Red/Green, Blue/Amber, Blue/Green or Amber/Green, Clear Lens
TMT0#	Stud Mount, DUO, Red/White, Blue/White, Amber/White, Green/White, Red/Blue, Red/Amber, Red/Green, Blue/Amber, Blue/Green or Amber/Green, Low Power, Clear Lens
TMT0#X	Stud Mount, DUO, Red/White, Blue/White, Amber/White, Green/White, Red/Blue, Red/Amber, Red/Green, Blue/Amber, Blue/Green or Amber/Green, Smoked Lens
TMT0#X	Stud Mount, DUO, Red/White, Blue/White, Amber/White, Green/White, Red/Blue, Red/Amber, Red/Green, Blue/Amber, Blue/Green or Amber/Green, Low Power, Clear Lens
TMT0#*	Stud Mount, TRIO Red/Blue/Amber, Red/Blue/White, Red/Blue/Green, Red/Amber/White, Red/Amber/Green, Red/Green/White, Green/Amber/White, Blue/Amber/Green, Blue/Green/White, Blue/Amber/White, Clear Lens
TMT0#*X	Stud Mount, TRIO Red/Blue/Amber, Red/Blue/White, Red/Blue/Green, Red/Amber/White, Red/Amber/Green, Red/Green/White, Green/Amber/White, Blue/Amber/Green, Blue/Green/White, Blue/Amber/White, Smoked Lens

Consult current price list for full list of available options at whelen.com/literature
 Replace * symbol in model number with letter indicating color desired:
 A = Amber, B = Blue, C = White, G = Green, R = Red
 Replace # symbol in model number with letter indicating DUO colors desired:
 D = Red/White, E = Blue/White, F = Amber/White, H = Green/White, J = Red/Blue,
 K = Red/Amber, L = Red/Green, M = Blue/Amber, N = Blue/Green, P = Amber/Green
 Replace #* symbol in model number with letter indicating TRIO colors desired:
 JA = Red/Blue/Amber, JC = Red/Blue/White, JG = Red/Blue/Green,
 KC = Red/Amber/White, KG = Red/Amber/Green, LC = Red/Green/White,
 MC = Blue/Amber/White, MG = Blue/Amber/Green, NC = Blue/Green/White,
 PC = Green/Amber/White

DIMENSIONS

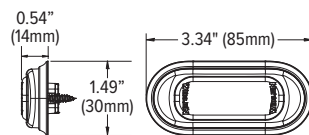

Mini T-Series with Surface Mount

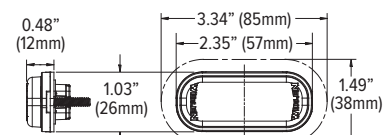

Mini T-Series with Stud Mount



Strip-Lite™ Plus Sequencing Light



Features available across product family. May not apply to every model.

FEATURES

- Sequencing features: left, right, split, and flashing patterns
- Surface mount via 2 screws for easy installation
- Black flange included
- Chrome flange option available
- IP67 rated
- Patented E Block™ technology prevents air and moisture from entering the lighthouse
- Symmetrical center-positioned wire exit
- 12" (30.48cm) pigtail cable included
- 12 VDC
- Amps: 1.93 (peak), 0.77 (avg.)

Model	Description
PSSEQACR	Sequencing Light, Amber, Clear Lens

Consult current price list for full list of available options at whelen.com/literature



DIMENSIONS

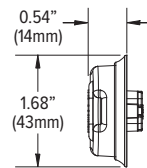
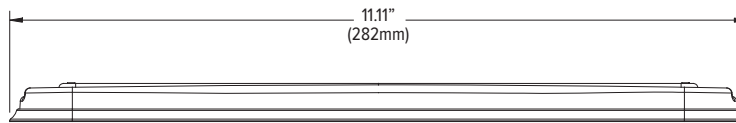

PSSEQACR Shown In Sequencing Mode

Strip-Lite™ Plus XL Tank Light



Features available across product family. May not apply to every model.

FEATURES

- Current volume level features full intensity illumination, while the rest of lighthouse is ghosted
- Low power mode
- Hard-coated lenses resist environmental damage from sand, sun, salt, and road chemicals
- Easily mounts to surface via two screws with included Black flange
- Optional Chrome flange available
- Symmetrical center positioned wire exit
- 12" (30.48cm) pigtail included
- E Block™ technology prevents air and moisture from entering lighthouse

Model	Description
PSTANK2	Fluid Level Indicator Light, Steady-Burn, Amber, Blue, Green and Red LEDs

Consult current price list for full list of available options at whelen.com/literature



DIMENSIONS

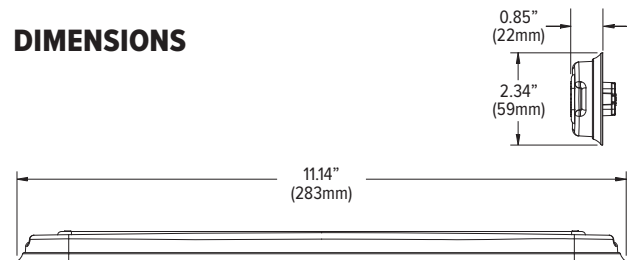

⚠ WARNING: This product may contain chemicals known to the State of California to cause cancer and birth defects or other reproductive harm. For more information, visit whelen.com/regulatory.

U-Series™



Features available across product family. May not apply to every model.

FEATURES

- Innovative U-shaped optics create 180° light output
- DUO™ or TRIO™ models available
- Universal or under-mirror mounting options available
- Conformal coated electronics for moisture and vibration resistance
- Hard-coated lenses resist environmental damage from sand, sun, salt, and road chemicals
- Smoked lenses available
- Synchronizes with other Whelen products
- 35 Scan-Lock™ flash patterns, including steady burn



U180KG

Model	Description
U180#	DUO, Clear Lens, Red/White, Blue/White, Amber/White, Green/White, Red/Blue, Red/Amber, Red/Green, Blue/Amber, Blue/Green, Amber/Green
U180#X	DUO, Smoked Lens, Red/White, Blue/White, Amber/White, Green/White, Red/Blue, Red/Amber, Red/Green, Blue/Amber, Blue/Green, Amber/Green
U180#*	TRIO, Clear Lens, Red/Blue/Amber, Red/Blue/White, Red/Blue/Green, Red/Amber/White, Red/Amber/Green, Red/Green/White, Blue/Amber/White, Blue/Amber/Green, Blue/Green/White, Green/Amber/White
U180#*X	TRIO, Smoked Lens, Red/Blue/Amber, Red/Blue/White, Red/Blue/Green, Red/Amber/White, Red/Amber/Green, Red/Green/White, Blue/Amber/White, Blue/Amber/Green, Blue/Green/White, Green/Amber/White

Consult current price list for full list of available options at whelen.com/literature.

Replace # symbol in model number with letter indicating DUO colors desired:

D = Red/White, E = Blue/White, F = Amber/White, H = Green/White, J = Red/Blue,

K = Red/Amber, L = Red/Green, M = Blue/Amber, N = Blue/Green, P = Amber/Green

Replace #* symbol in model number with letter indicating TRIO colors desired:

JA = Red/Blue/Amber, JC = Red/Blue/White, JG = Red/Blue/Green, KC = Red/Amber/White,

KG = Red/Amber/Green, LC = Red/Green/White, MC = Blue/Amber/White,

MG = Blue/Amber/Green, NC = Blue/Green/White, PC = Green/Amber/White



DIMENSIONS

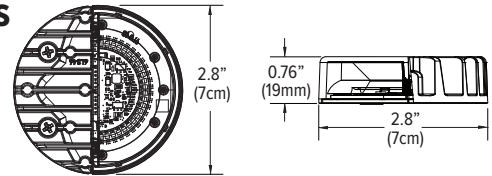

ION® V-Series™



Features available across product family. May not apply to every model.

FEATURES

- SAE Class 1 Certified
- Linear Super-LED® optics
- Available in 3-in-1 combination warning, spotlight, and ground illumination light or in single-color warning-only models
- Black, White or Chrome housing
- Single-color models have combination 180° and TIR™ directional warning
- Hard-coated lenses resist environmental damage from sand, sun, salt, and road chemicals
- Smoked lenses available



IONSV3R



IONV3R

Model	Description
IONV3*	Universal Mount, Black Housing, Amber, Blue, White, Green or Red with White Illumination
IONSV3*	Surface Mount, Black Housing, Amber, Blue, White, Green or Red with White Illumination
IONSV3*W	Surface Mount, White Housing, Amber, Blue, White or Red with White Illumination
IONSV3*C	Chrome Housing, Surface Mount, Amber, Blue, White or Red with White Illumination
IONV1*	Linear and TIR Super-LED, Universal Mount, Black Housing, Amber, Blue, White or Red
IONSV1*	Linear and TIR Super-LED, Surface Mount, Black Housing, Amber, Blue, White or Red
IONSV1*C	Linear and TIR Super-LED, Surface Mount, Chrome Housing, Amber, Blue, White or Red

Consult current price list for full list of available options at whelen.com/literature

Replace * symbol in model number with

letter indicating color desired:

A = Amber, B = Blue, C = White, G = Green, R = Red



DIMENSIONS

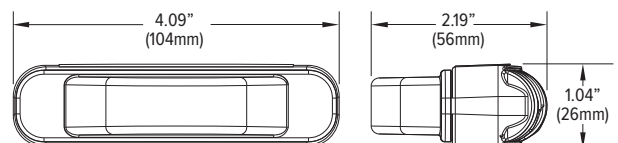

Universal Mount

Micron™ Series



Features available across product family. May not apply to every model.

FEATURES

- Easily mounts to surface via two screws
- TIR™ Super-LED® optics
- Hard-coated lenses resist environmental damage from sand, sun, salt, and road chemicals



MCRNTD



MCRNSCR

Model	Description
MCRNS*	Surface Mount, Black Flange, Amber, Blue, White, Green or Red
MCRNSC*	Surface Mount, Chrome Flange, Amber, Blue, White, Green or Red
MCRNS#	Surface Mount, Linear Split-Color Super-LED, Black Flange, Red/White, Blue/White, Amber/White, Red/Blue, Red/Amber, Blue/Amber or Amber/Green
MCRNSC#	Surface Mount, Linear Split-Color Super-LED, Chrome Flange, Red/White, Blue/White, Amber/White, Red/Blue, Red/Amber or Blue/Amber
MCRNT*	Stud Mount, Amber, Blue, White, Green or Red
MCRNT#	Stud Mount, Linear Split-Color Super-LED, Red/White, Blue/White, Amber/White, Red/Blue, Red/Amber, Blue/Amber or Amber/Green

Consult current price list for full list of available options at whelen.com/literature
 Replace * symbol in model number with letter indicating color desired:
 A = Amber, B = Blue, C = White, G = Green, R = Red
 Replace # in model number with interleaved color desired: D = Red/White, E = Blue/White,
 F = Amber/White, J = Red/Blue, K = Red/Amber, M = Blue/Amber or P = Amber/Green



DIMENSIONS

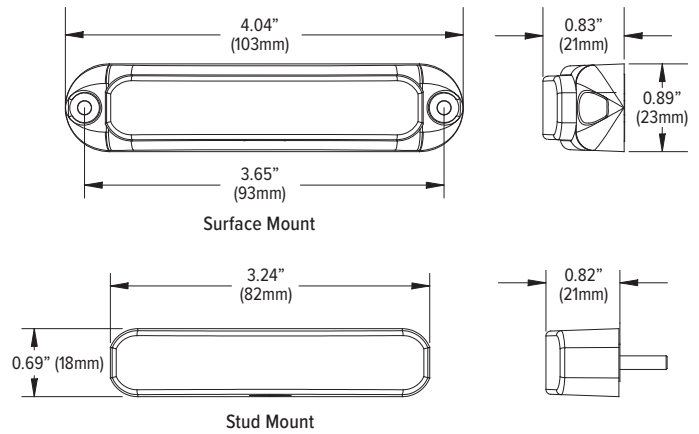

V23™ Series



Features available across product family. May not apply to every model.

FEATURES

- Models have 3-in-1 180° wide-angle warning, illumination, and puddle light
- Hard-coated lenses resist environmental damage from sand, sun, salt, and road chemicals
- Easily mounts to surface via two screws for easy installation
- Smoked lenses available
- Available in steady-burn or with an internal flasher



V23RTPB

Model	Description
V23*TPB	V-Series™ Super-LED® Amber, Blue, White or Red with White Illumination, Includes Black Flange
V23*TPC	V-Series Super-LED, Amber, Blue, White or Red with White Illumination, Includes Chrome Flange
V23P20B	20° Angled Surface Mount Housing, Black
V23P20C	20° Angled Surface Mount Housing, Chrome

Consult current price list for full list of available options at whelen.com/literature
 Replace * symbol in model number with letter indicating color desired: A = Amber, B = Blue, C = White, R = Red



DIMENSIONS

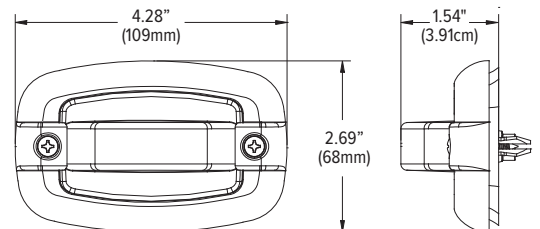

⚠ WARNING: This product may contain chemicals known to the State of California to cause cancer and birth defects or other reproductive harm. For more information, visit whelen.com/regulatory.

ION® Series



Features available across product family. May not apply to every model.



IONSMR



IONB

FEATURES

- SAE Class 1 Certified
- SOLO™ models available in single or split-colors
- DUO™ and TRIO™ models feature Linear Super-LED® optics
- Hard-coated lenses resist environmental damage from sand, sun, salt, and road chemicals
- Smoked lenses available
- Surface or universal mount

Model	Description
ION*	Directional Linear Super-LED, Universal Mount, Amber, Blue, White, Green or Red
ION#	Directional Linear Split-Color Super-LED, Universal Mount, Red/White, Blue/White, Amber/White, Red/Blue, Red/Amber or Blue/Amber
WION*	Wide-Angle Linear Super-LED, Universal Mount, Amber, Blue, White, Green or Red
WION#	Wide-Angle Linear Super-LED, Universal Mount, Red/White, Blue/White, Amber/White, Red/Blue, Red/Amber, Red/Green or Blue/Amber
IONSM*	Directional Linear Super-LED, Surface Mount, Amber, Blue, White, Green or Red
IONSMC*	Directional Linear Super-LED, Surface Mount, Chrome Housing, Amber, Blue, White, Green or Red
IONSM#	Directional Linear Super-LED, Surface Mount, Red/White, Blue/White, Amber/White, Green/White, Red/Blue, Red/Amber or Blue/Amber
IONSMC#	Directional Linear Super-LED, Surface Mount, Chrome Housing, Red/White, Blue/White, Amber/White, Green/White, Red/Blue, Red/Amber or Blue/Amber
WIONSM*	Wide-Angle Linear Super-LED, Surface Mount, Amber, Blue, White, Green or Red
WIONSMC*	Wide-Angle Linear Super-LED, Surface Mount, Chrome Housing, Amber, Blue, White, Green or Red
WIONSM#	Wide-Angle Linear Super-LED, Surface Mount, Red/White, Blue/White, Amber/White, Green/White, Red/Blue, Red/Amber or Blue/Amber
I2#	Linear DUO Super-LED, Universal Mount, Red/White, Blue/White, Amber/White, Green/White, Red/Blue, Red/Amber, Red/Green, Blue/Amber or Amber/Green
I2SM#	Linear DUO Super-LED, Surface Mount, Red/White, Blue/White, Amber/White, Green/White, Red/Blue, Red/Amber, or Blue/Amber
I3#*	Linear TRIO Super-LED, Universal Mount, Red/Blue/Amber, Red/Blue/White, Red/Amber/White, Red/Green/White or Blue/Amber/White
I3SM#*	Linear TRIO Super-LED, Surface Mount, Red/Blue/Amber, Red/Blue/White, Red/Amber/White, Blue/Amber/White or Green/Amber/White

Consult current price list for full list of available options at whelen.com/literature

Replace * symbol in model number with letter indicating color desired: A = Amber, B = Blue, C = White, G = Green, R = Red

Replace # in model number with interleaved color desired: D = Red/White, E = Blue/White, F = Amber/White, H = Green/White, J = Red/Blue, K = Red/Amber, L = Red/Green, M = Blue/Amber

Replace #* symbol in model number with letter indicating TRIO colors desired: JA = Red/Blue/Amber, JC = Red/Blue/White, KC = Red/Amber/White, LC = Red/Green/White,

MC = Blue/Amber/White, PC = Green/Amber/White



DIMENSIONS

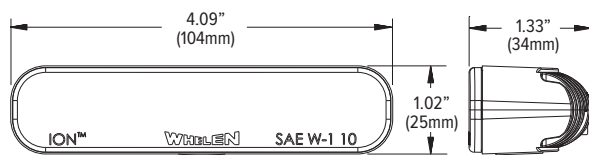

Universal Mount

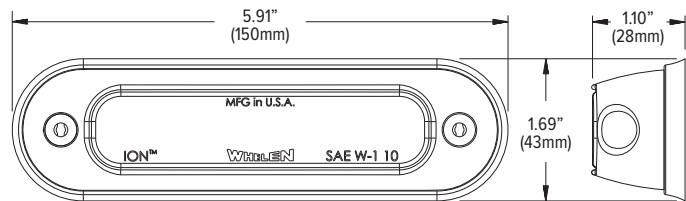

Surface Mount

LINV2™ V-Series™



Features available across product family. May not apply to every model.

FEATURES

- Combination 180° warning and puddle light
- Black flange included
- Hard-coated lenses resist environmental damage from sand, sun, salt, and road chemicals



LINV2R

Model	Description
LINV2*	Surface Mount, Super-LED®, Amber, Blue, White, Green or Red
LINSV2*	Under Surface Mount, Super-LED, Amber, Blue, White, Green or Red

Consult current price list for full list of available options at whelen.com/literature

Replace * symbol in model number with letter indicating color desired:

A = Amber, B = Blue, C = White, G = Green, R = Red



DIMENSIONS

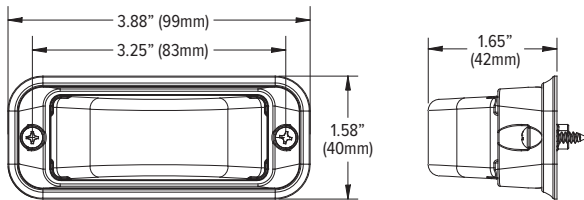

LINV2 Surface Mount

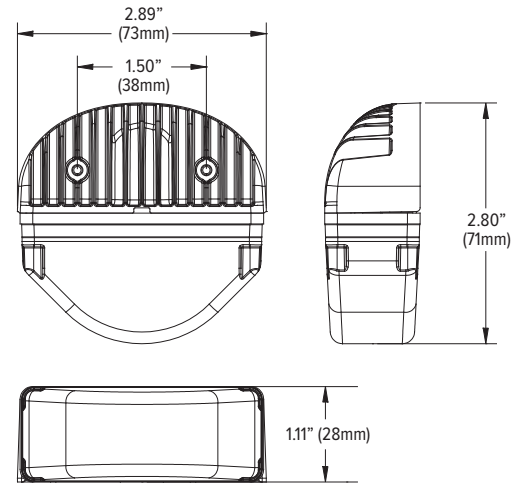

LINSV2 Under Surface Mount

OS™ Series



Features available across product family. May not apply to every model.

FEATURES

- Fully encapsulated
- Chrome housing or black flange included
- Clear outer lens, Color LEDs



OSR00MCR



OACOEDCR

Model	Description
OS*00MCR	Amber, Blue, Green or Red Marker/Clearance Light with Clear Lens, Chrome Flange
OS*00FCR	Amber, Blue, White or Red Single Flash and Clear Lens, Chrome Flange
OS*00SCR	Amber, Blue, Green or Red Steady-Burn and Clear Lens, Chrome Flange
OSCOEDCR	White Illumination Light with Clear Lens, Chrome Flange
OACOEDCR	White Illumination Light with Clear Lens and 45° Angled Chrome-Plated Bezel
OB*00MCR	Amber or Red Marker/Clearance Light with Clear Lens, Black Flange
OB*00FCR	Amber, Blue, White or Red Single Flash and Clear Lens, Black Flange
OB*00SCR	Steady-Burn and Clear Lens, Black Flange
OBCOEDCR	White Illumination Light with Clear Lens, Black Flange

Replace * symbol in model number with letter indicating color desired:

A = Amber, B = Blue, C = White, G = Green, R = Red



DIMENSIONS

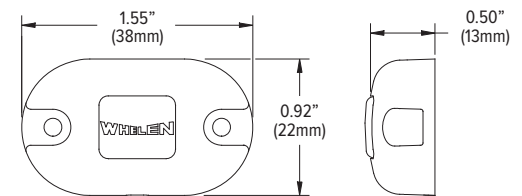

Chrome Flange

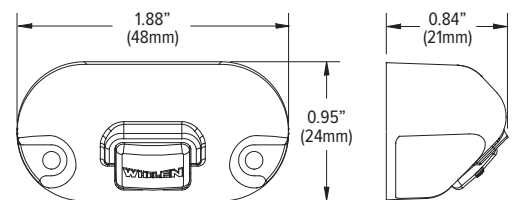

45° Angled Chrome-Plated Bezel

⚠ WARNING: This product may contain chemicals known to the State of California to cause cancer and birth defects or other reproductive harm. For more information, visit whelen.com/regulatory.

VXE® Series



Features available across product family. May not apply to every model.



VX3RAC



VX2#

FEATURES

- DUO™ and TRIO™ functionality
 - DUO: 8 LEDs
 - TRIO: 12 LEDs
- Directional light output
- Low-profile/compact design
- Steady only (CORE® Suite or external flasher required) or SmartLED® models available
- 25mm mounting grommet
- Smoked lenses available

Model	Description
VX2#	Directional DUO Lighthouse, Clear Lens, Red/White, Blue/White, Amber/White, Green/White, Red/Blue, Red/Amber, Red/Green, Blue/Amber, Blue/Green, Amber/Green
VX3***	Directional TRIO Lighthouse, Clear Lens, Blue/Amber/White, Blue/Amber/Green, Blue/Green/White, Green/Amber/White, Red/Amber/White, Red/Amber/Green, Red/Blue/Amber, Red/Blue/White, Red/Blue/Green, Red/Green/White
VX2#X	Directional DUO Lighthouse, Smoked Lens, Red/White, Blue/White, Amber/White, Green/White, Red/Blue, Red/Amber, Red/Green, Blue/Amber, Blue/Green, Amber/Green
VX3***X	Directional TRIO Lighthouse, Smoked Lens, Blue/Amber/White, Blue/Amber/Green, Blue/Green/White, Green/Amber/White, Red/Amber/White, Red/Amber/Green, Red/Blue/Amber, Red/Blue/White, Red/Blue/Green, Red/Green/White
VXF2#	Directional DUO SmartLED Lighthouse, Clear Lens, Red/White, Blue/White, Amber/White, Green/White, Red/Blue, Red/Amber, Red/Green, Blue/Amber, Blue/Green, Amber/Green, Embedded Flasher with 27 Built-In Flash Patterns, 9" (22.86cm) Pigtail
VXF2#X	Directional DUO SmartLED Lighthouse, Smoked Lens, Red/White, Blue/White, Amber/White, Green/White, Red/Blue, Red/Amber, Red/Green, Blue/Amber, Blue/Green, Amber/Green, Embedded Flasher with 27 Built-In Flash Patterns, 9" (22.86cm) Pigtail

Replace # symbol in model number with letter indicating DUO colors desired:
 D = Red/White, E = Blue/White, F = Amber/White, H = Green/White, J = Red/Blue, K = Red/Amber, L = Red/Green, M = Blue/Amber, N = Blue/Green, P = Amber/Green
 Replace *** symbol in model number with letter indicating TRIO colors desired:
 BAC = Blue/Amber/White, BAG = Blue/Amber/Green, BGC = Blue/Green/White, GAC = Green/Amber/White, RAC = Red/Amber/White,
 RAG = Red/Amber/Green, RBA = Red/Blue/Amber, RBC = Red/Blue/White, RBG = Red/Blue/Green, RGC = Red/Green/White



OPTIONS

Model	Description
PLF46	Programmable Light Flasher, Four Inputs, Six Outputs (30 Amps Total), Includes DVI™ and Steady-Lock®
ULF44	Four Outlet, Four Channel LED Flasher, 60 Watts Per Outlet, More Than 60 Scan-Lock™ Flash Patterns, Allowing for Alternating, Simultaneous and Synchronized Flashing Lighthoods
SLFLASH	SmartLogic™ Programmable Flasher, Eight Inputs, Eight Outputs (5 amps per output), 64 Scan-Lock flash patterns

DIMENSIONS

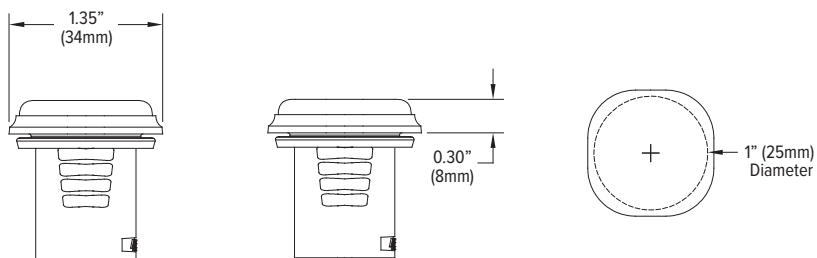

Vertex™ Series



Features available across product family. May not apply to every model.



VTX609R

FEATURES

- Directional, omnidirectional, and side emitter models available
- Designed to mount in composite style headlight or taillight, or surface mount to exterior surfaces with flange mount option
- Ballast is fully encapsulated for moisture, vibration, and corrosion resistance
- Hard-coated lenses resist environmental damage from sand, sun, salt, and road chemicals
- Clear outer lens, Color LEDs
- Smoked lenses available

Model	Description
VTX609*	Recess or Surface Mount, Omnidirectional Super-LED®, Amber, Blue, White, Green or Red
VTX9#	Recess or Surface Mount, Omnidirectional Super-LED, DUO™ Red/White, Blue/White, Amber/White, Green/White, Red/Blue, Red/Amber, Blue/Amber or Amber/Green
VTXD609*	Recess or Surface Mount, Directional/Side Emitting Shield Super-LED, Amber, Blue, White, Green or Red
VTX3609*	Recess Mount, 360° Side Emitter Super-LED, Amber, Blue, White, Green or Red

Consult current price list for full list of available options at whelen.com/literature

Replace * symbol in model number with letter indicating color desired: A = Amber, B = Blue, C = White, G = Green, R = Red

Replace # in model number with interleaved color desired: D = Red/White, E = Blue/White, F = Amber/White, H = Green/White, J = Red/Blue, K = Red/Amber, M = Blue/Amber, P = Amber/Green



DIMENSIONS

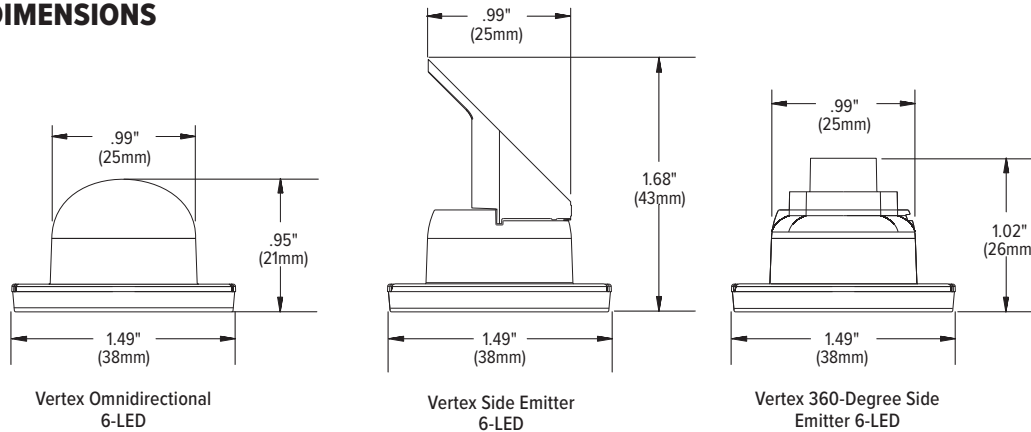

⚠ WARNING: This product may contain chemicals known to the State of California to cause cancer and birth defects or other reproductive harm. For more information, visit whelen.com/regulatory.

2" Round Series



Features available across product family. May not apply to every model.

FEATURES

- Hard-coated lenses resist environmental damage from sand, sun, salt, and road chemicals
- Fully encapsulated for moisture, vibration and corrosion resistance
- Recessed Black flange included
- Optional Chrome flange available

Model	Description
TOA00MAR	2" Round, LED, Marker or Clearance Light, Amber
TOR00MRR	2" Round, LED, Marker or Clearance Light, Red
TFLANGEC	Flange Kit, Surface Mount, Chrome

Consult current price list for full list of available options at whelen.com/literature

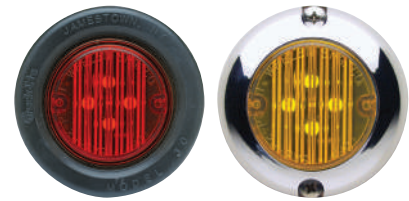

TOR00MRR

TOA00MAR

DIMENSIONS

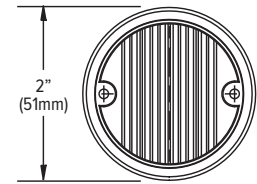

3" Round Series



Features available across product family. May not apply to every model.

FEATURES

- Hard-coated lenses resist environmental damage from sand, sun, salt, and road chemicals
- Clear or Color lenses available

Model	Description
3S*00F*R	3" Round Surface Mount LED, Amber, Blue, White or Red

Consult current price list for full list of available options at whelen.com/literature

Replace * symbol in model number with letter indicating color desired:
A = Amber, B = Blue, C = White, R = Red



3S00FRR

3SA00FAR

3SC00FCR

DIMENSIONS

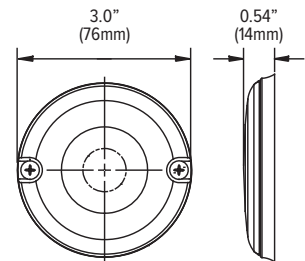

4" Round Series



Features available across product family. May not apply to every model.

FEATURES

- Hard-coated lenses resist environmental damage from sand, sun, salt, and road chemicals
- Supplied with adapter for PAR-36 (4.5") applications
- Fully encapsulated mounting hardware

Model	Description
2F*00Z*R	Flat Lens, TIR6™ Super-LED®, Amber, Blue, White, Green or Red
2E*00Z*R	Extended Lens, LINZ6™ Super-LED, Amber, Blue, White, Green or Red
2E#00ZCR	Extended Lens, LINZ6 Super-LED, Red/White, Blue/White, Amber/White, Red/Blue, Amber/Green

Consult current price list for full list of available options at whelen.com/literature

Replace * symbol in model number with letter indicating color desired:
A = Amber, B = Blue, C = White, G = Green, R = Red

Replace # in model number with interleaved color desired:
D = Red/White, E = Blue/White, F = Amber/White, J = Red/Blue, P = Amber/Green



2FA00ZRR

2EA00ZAR

DIMENSIONS

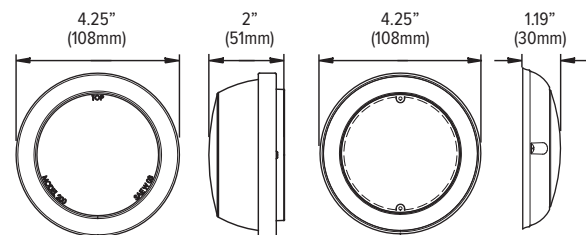

4" Round Extended Lens

4" Round Flat Lens

TIR3™, LIN3™, & LINZ6™ Series



Features available across product family. May not apply to every model.



LINZ6™



LIN3™



TIR3™

FEATURES

- Hard-coated lenses resist environmental damage from sand, sun, salt, and road chemicals
- Fully encapsulated for moisture, vibration and corrosion resistance

Model	Description
RS*03ZCR	Horizontal Surface Mount, TIR3™ Super-LED®, Amber, Blue, White, Green or Red
RV*03ZCR	Vertical Surface Mount, TIR3 Super-LED, Amber, Blue, White, Green or Red
RS*02ZCR	Horizontal Surface Mount, LIN3™ Super-LED, Amber, Blue, White, Green or Red
LINZ6*	Horizontal Surface Mount, LINZ6™ Super-LED, Amber, Blue, White, Green or Red
LINZ6#	Horizontal Surface Mount, LINZ6 Super-LED, Red/White, Blue/White, Amber/White, Red/Blue, Red/Amber, Red/Green or Blue/Amber
LINZ61	Horizontal Surface Mount, LINZ6 Super-LED, Amber/Amber
LINZ62	Horizontal Surface Mount, LINZ6 Super-LED, Blue/Blue
LINZ65	Horizontal Surface Mount, LINZ6 Super-LED, Red/Red

Consult current price list for full list of available options at whelen.com/literature

Replace * symbol in model number with letter indicating color desired: A = Amber, B = Blue, C = White, G = Green, R = Red

Replace # in model number with interleaved color desired: D = Red/White, E = Blue/White, F = Amber/White, J = Red/Blue, K = Red/Amber, L = Red/Green, M = Blue/Amber



DIMENSIONS

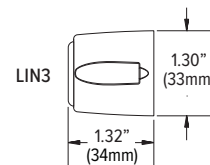
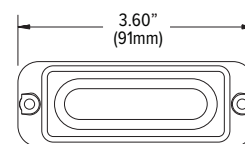
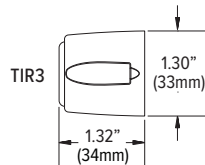
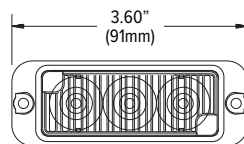
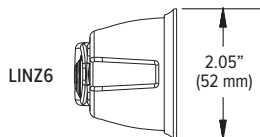
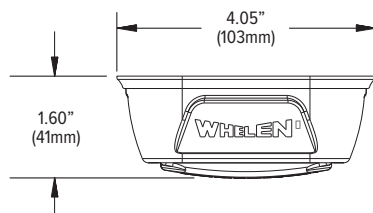

⚠ WARNING: This product may contain chemicals known to the State of California to cause cancer and birth defects or other reproductive harm. For more information, visit whelen.com/regulatory.

Brake/Tail/Turn Lights



Features available across product family. May not apply to every model.

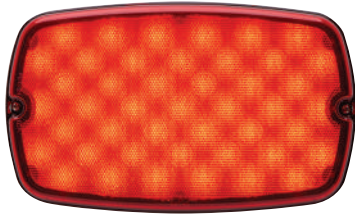

M62BTT



404BTT



704BTT



M92BTT

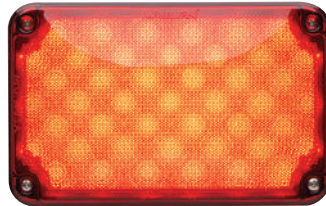

604BTT

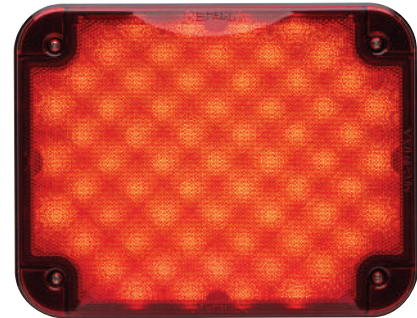

904BTT

FEATURES

- Mounts to surface via two or four screws
- Fully encapsulated for moisture, vibration, and corrosion resistance
- Hard-coated lenses minimize environmental damage from sand, sun, salt, and road chemicals
- E Block™ technology prevents air and moisture from entering the lighthouse
- A variety of mounting brackets and optional Black and Chrome flanges are available
- Meets FMVSS and SAE requirements

Model	Description
M62BTT	M6 Series, LED, Red
M92BTT	M9 Series, LED, Red
404BTT	400 Series, LED, Red
604BTT	600 Series, LED, Red
704BTT	700 Series, LED, Red
904BTT	900 Series, LED, Red

Consult current price list for full list of available options at whelen.com/literature
To order with a clear lens add a "C" to the end of the model number



OPTIONS



PLAST3V Flange



PLAST4V Flange



M6FCV3 Flange



M6FCV4 Flange

Turn Signals



Features available across product family. May not apply to every model.

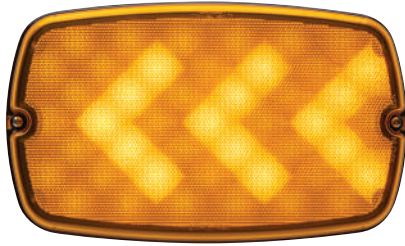

M92T

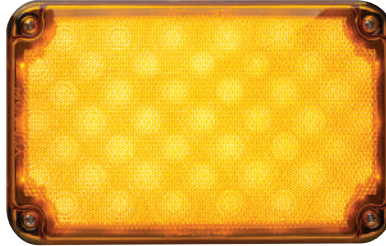

604T

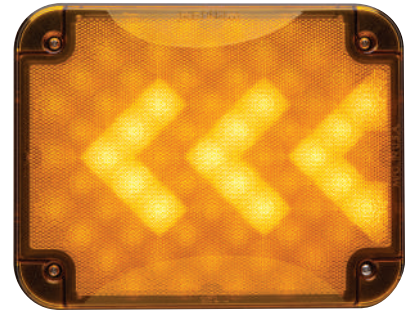

904T



704T



M62T

FEATURES

- Mounts to surface via two or four screws
- Arrows may be mounted left or right
- Hard-coated lenses minimize environmental damage from sand, sun, salt, and road chemicals
- E Block™ technology prevents air and moisture from entering the lighthouse
- Variety of mounting brackets and optional Black and Chrome flanges are available
- Meets FMVSS and SAE requirements

Model	Description
M62T	M6 Series, Amber LED, Turn Light
M92T	M9 Series, Amber LED, Turn Light
404T	400 Series, Amber LED, Turn Light
604T	600 Series, Amber Turn Signal, Populated Arrow
704T	700 Series, Amber Turn Signal, Sequential Chevron Arrow
904T	900 Series, Amber Turn Signal, Populated Left/Right Arrow

Consult current price list for full list of available options at whelen.com/literature
To order with a clear lens add a "C" to the end of the model number



⚠ WARNING: This product may contain chemicals known to the State of California to cause cancer and birth defects or other reproductive harm. For more information, visit whelen.com/regulatory.

Back-Up Lights



Features available across product family. May not apply to every model.



M62BU



M92BU



604BU



404BUH



704BU



5GBUV



404BUV

FEATURES

- Mounts to surface via two or four screws
- Hard-coated lenses minimize environmental damage from sand, sun, salt, and road chemicals
- E Block™ technology prevents air and moisture from entering the lighthouse
- A variety of mounting brackets and optional Black and Chrome flanges are available
- Meets FMVSS and SAE requirements
- 5G Series is fully encapsulated

Model	Description
5GBUV	Super-LED® Back-up Light, Vertical Mount, White
M62BU	M6 Series, Super-LED, White
M92BU	M9 Series, Super-LED, White
404BUH	400 Series, Super-LED, White, Horizontal Mount
404BUV	400 Series, Super-LED, White, Vertical Mount
604BU	600 Series, LED, White
704BU	700 Series, LED, White

Consult current price list for full list of available options at whelen.com/literature



TRAFFIC ADVISOR™



Traffic Advisor™ Flat Mount

 **WARNING:** This product may contain chemicals known to the State of California to cause cancer and birth defects or other reproductive harm. For more information, visit whelen.com/regulatory.

WHELEN
MANUFACTURED IN AMERICA

Traffic Advisor™ 2200 Series



Features available across product family. May not apply to every model.



TACTL5



TA2240F

FEATURES

- Utilizes powerful T-Series™ lighthead with patented E Block™ technology
- IP67 Rated
- Compatible with TACTL5 control head and CTA module
- TACTL5 control head included
- Low current switching
- Hard-coated lenses resist environmental damage from sand, sun, salt, and road chemicals
- Slide bolt mount
- Includes 2 flat end caps
- 15' (4.57m) cable standard, alternate cable lengths available, contact factory

Model	Description
TA2230F	31.98" (81.23cm) Long, Six Amber Lighthead Traffic Advisor with Flat End Caps
TA2240F	42.08" (107cm) Long, Eight Amber Lighthead Traffic Advisor with Flat End Caps

DIMENSIONS

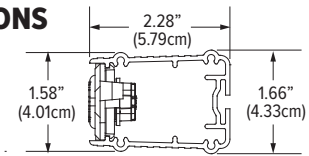

Traffic Advisor Dominator™ Series



Features available across product family. May not apply to every model.



DTA6



TADCTL1



DPTA8A

FEATURES

- Interior or exterior applications
- Extruded aluminum housing
- Left arrow, right arrow, split arrow, and warning function
- 15' (4.57m) cable standard, alternate cable lengths available, contact factory

Model	Description
DTA6	Dominator Traffic Advisor, Requires Six D* Lighthead, TADCTL1 Control Head Not Included
DTA6A	Dominator Traffic Advisor with Six TIR3™ Amber Lighthead, TADCTL1 Control Head Not Included
DTA8A	Dominator Traffic Advisor with Eight TIR3 Amber Lighthead, TADCTL1 Control Head Not Included
DTA8	Dominator Traffic Advisor, Requires Eight D* Lighthead, TADCTL1 Control Head Not Included
DTAW8	Dominator Traffic Advisor, Requires Eight D* Lighthead (6 Amber, 2 End Warning), TADCTL1 Control Head Not Included
DPTA6A	Dominator Plus Traffic Advisor with Six LINZ6™ Amber Lighthead, TADCTL1 Control Head Not Included
DPTA6	Dominator Plus Traffic Advisor, Requires Six DP* Lighthead, TADCTL1 Control Head Not Included
DPTA8A	Dominator Plus Traffic Advisor with Eight LINZ6 Amber Lighthead, TADCTL1 Control Head Not Included
DPTA8	Dominator Plus Traffic Advisor, Requires Eight DP* Lighthead, TADCTL1 Control Head Not Included
DPTAW8	Dominator Plus Traffic Advisor, Requires Eight DP* Lighthead (6 Amber, 2 End Warning), TADCTL1 Control Head Not Included
DP*	LINZ6 Super-LED® Lighthead, Amber, Blue, White, or Red
D*	TIR3 Super-LED Lighthead, Amber, Blue, White, or Red

* Replace symbol in model number with letter indicating desired color: A = Amber, B = Blue, C = White, R = Red
Consult current price list for full list of available options at whelen.com/literature.



DIMENSIONS

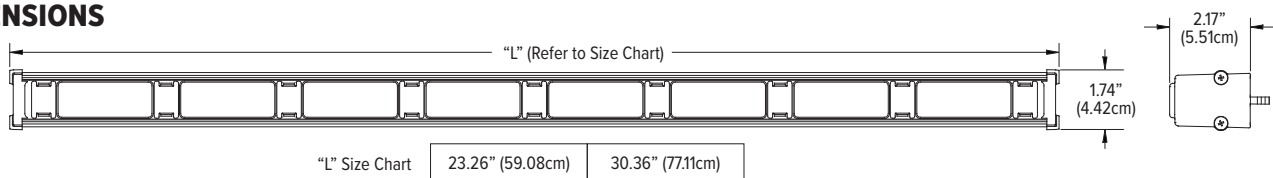

Traffic Advisor™ Rear Slot Mount

5YR ISOLO™

Features available across product family. May not apply to every model.



FEATURES

- Interior or exterior applications
- Extruded aluminum housing
- Left arrow, right arrow, split arrow, and warning function
- 15' (4.57m) cable standard, alternate cable lengths available, contact factory
- Split-color options available

Model	Description
TAM63	Traffic Advisor with Six TIR3™ Lighthoods, TACTL5 Control Head Included
TAM83	Traffic Advisor with Eight TIR3 Lighthoods, TACTL5 Control Head Included
TAM83**	Traffic Advisor with Eight TIR3 Lighthoods, TACTL5 Control Head Included
TAZ66	Traffic Advisor with Six LINZ6™ Lighthoods, TACTL5 Control Head Included
TAZ86	Traffic Advisor with Eight LINZ6 Lighthoods, TACTL5 Control Head Included
TAZ86**	Traffic Advisor with Eight LINZ6 Lighthoods, TACTL5 Control Head Included

* Replace symbol in model number with letter indicating desired color: A = Amber, C=White
Consult current price list for full list of available options at whelen.com/literature.



Traffic Advisor Flat Mount

5YR ISOLO™

Features available across product family. May not apply to every model.



FEATURES

- Interior or exterior applications
- Extruded aluminum housing
- Left arrow, right arrow, split arrow, and warning function

Model	Description
TA4437M	Traffic Advisor with Eight 500 Series 5mm LED Lighthoods, Two Piece TACTL5 Control Head Included
TAL65	Traffic Advisor with Six 500 Series 5mm LED Lighthoods, TACTL5 Control Head Included
TAL85	Traffic Advisor with Eight 500 Series 5mm LED Lighthoods, TACTL5 Control Head Included
TAM65	Traffic Advisor with Six TIR6™ 500 Series Lighthoods, TACTL5 Control Head Included
TAM85	Traffic Advisor with Eight TIR6 500 Series lighthoods, TACTL5 Control Head Included
TAM85**	Traffic Advisor with Eight TIR6 500 Series Lighthoods, TACTL5 Control Head Included

* Replace symbol in model number with letter indicating desired color: A = Amber, C = White
** Indicates flashing end modules
Consult current price list for full list of available options at whelen.com/literature.



⚠ WARNING: This product may contain chemicals known to the State of California to cause cancer and birth defects or other reproductive harm. For more information, visit whelen.com/regulatory.

Traffic Advisor™ Front Load



Features available across product family. May not apply to every model.



TACF85



TANF65



TACTL5

FEATURES

- Interior or exterior applications
- Extruded aluminum housing
- Left arrow, right arrow, split arrow, and warning function
- 15' (4.57m) cable standard, alternate cable lengths available, contact factory

Model	Traffic Advisor Front Load Series Description
TADF6	Traffic Advisor with Six DUO™ Linear Super-LED® Lightheads, No Control Head Required
TADF8	Traffic Advisor with Eight DUO Linear Super-LED Lightheads, No Control Head Required
TANF65	Traffic Advisor with Six 500 Series Linear-LED® Lightheads, TACTL5 Control Head Included
TANF85	Traffic Advisor with Eight 500 Series Linear-LED Lightheads, TACTL5 Control Head Included
TANF85**	Traffic Advisor with Eight 500 Series Linear-LED Lightheads, TACTL5 Control Head Included
TACF85	Traffic Advisor with Eight CON3™ Super-LED Lightheads, TACTL5 Control Head Included
TACF85**	Traffic Advisor with Eight CON3 Super-LED Lightheads, TACTL5 Control Head Included

* Replace symbol in model number with letter indicating desired color: A = Amber, B = Blue, C = White, R = Red
Consult current price list for full list of available options at whelen.com/literature.



Traffic Advisor TAC8 (Economy)



Features available across product family. May not apply to every model.



FEATURES

- TAC8 compact control head easily mounted 3 different ways: VHB Tape, Velcro®, or Permanent mount hardware
- Extruded aluminum housing
- Left arrow, right arrow, split arrow, and warning function
- Rear dip switch provides 8 flash pattern choices

Model	Traffic Advisor TAC8 (Economy) Series Description
TAC815	Traffic Advisor with Eight SOLO™ Super-LED Lightheads, 15' (4.57m) Cable and Control Head Included
TAC830	Traffic Advisor with Eight SOLO Super-LED Lightheads, 30' (9.14m) Cable and Control Head Included
TAC850	Traffic Advisor with Eight SOLO Super-LED Lightheads, 50' (15.24m) Cable and Control Head Included



BEACONS

L31 Series



 **WARNING:** This product may contain chemicals known to the State of California to cause cancer and birth defects or other reproductive harm. For more information, visit whelen.com/regulatory.

WHELEN
MANUFACTURED IN AMERICA

B6 Series Combination Tailboard Lighting



Features available across product family.
May not apply to every model.

FEATURES

- Designed for use in NFPA 1900 Specification lighting packages
- Combines 360° warning and directional lighting
- Hard-coated domes and lenses resist environmental damage from sand, sun, salt, and road chemicals
- Lower light offered in single or split-color
- Polished aluminum base



B63M7RR

Model	Description
B63M7**	R316 Super-LED® Rota-Beam™ Beacon Upper, with M7 Super-LED Lighthouse
B6370**	R316 Super-LED Rota-Beam Beacon Upper, with 700 Series Super-LED Lighthouse Lower
B6MM**P	L31 Super-LED Beacon Upper, with 700 Series Super-LED Lighthouse Lower
B6M7**P	L31 Super-LED Beacon with Polished Base, Upper Section and M7 Super-LED® Directional Lighthouse in Lower Section

Consult current price list for full list of available options at whelen.com/literature

Replace * symbol in model number with letter indicating color desired: A = Amber, B = Blue, C = White, G = Green, R = Red

To order Clear lenses add corresponding number to the end of model number 1 = A, 2 = B, 4 = G, 5 = R



DIMENSIONS

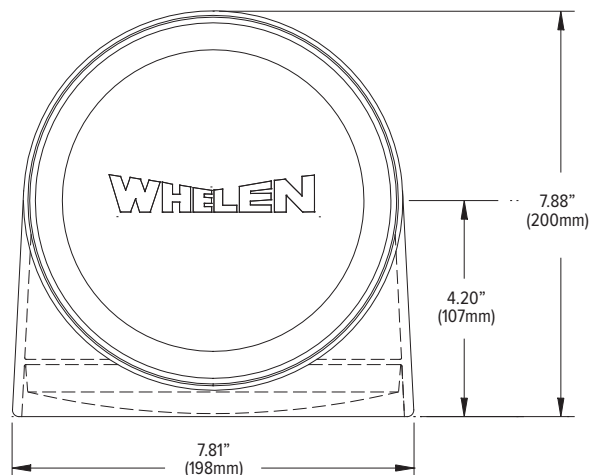
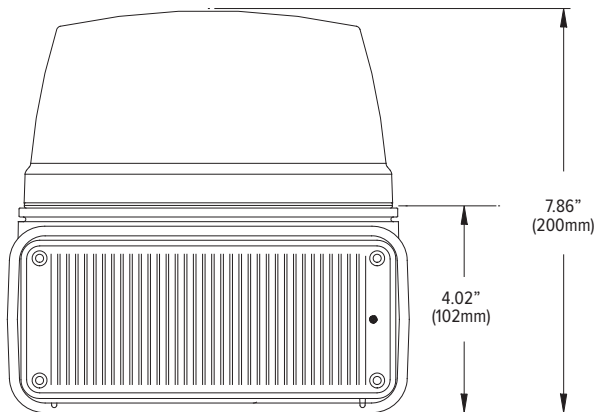

R316 & R416 Series



Features available across product family. May not apply to every model.



R316RF



R416RF

FEATURES

- SAE Class 1 Certified
- Smooth polycarbonate dome
- Powder-coated die-cast base
- Conformal coated electronics
- Hard-coated domes resist environmental damage from sand, sun, salt, and road chemicals

Model	Description
R316*F	Permanent Mount, Amber, Blue, White, Green or Red
R316*M	Magnetic Mount, Amber, Blue, White or Red
R316*V	Magnetic/Suction Mount, Amber, Blue, White, Green or Red
R316**F	Permanent Mount, Two-Color, Split Front/Rear, Amber, Blue, White and/or Red
R316**M	Magnetic Mount, Two-Color, Split Front/Rear, Amber, Blue, White and/or Red
R316**V	Magnetic/Suction Mount, Two-Color, Split Front/Rear, Amber, Blue, White and/or Red
R416*F	Permanent Mount, Amber, Blue, White, Green or Red
R416*M	Magnetic Mount, Amber, Blue, White or Red
R416*V	Magnetic/Suction Mount, Amber, Blue, White, Green or Red
R416**F	Permanent Mount, Two-Color, Split Front/Rear, Amber, Blue, White or Red
R416**M	Magnetic Mount, Two-Color, Split Front/Rear, Amber, Blue, White or Red
R416**V	Magnetic/Suction Mount, Two-Color, Split Front/Rear, Amber, Blue, White or Red

Consult current price list for full list of available options at whelen.com/literature

Replace * symbol in model number with letter indicating color desired: A = Amber, B = Blue, C = White, G = Green, R = Red
To order Clear lenses add corresponding number to the end of model number 1 = A, 2 = B, 4 = G, 5 = R



DIMENSIONS

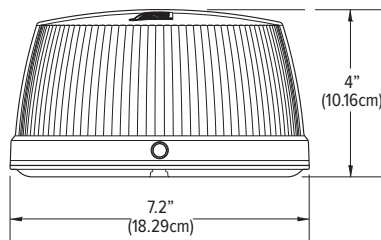

R316 Series

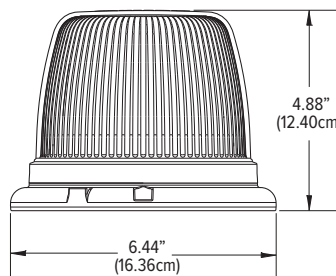

R416 Series

⚠ WARNING: This product may contain chemicals known to the State of California to cause cancer and birth defects or other reproductive harm. For more information, visit whelen.com/regulatory.

L31 & L32 Super-LED® Series



Features available across product family. May not apply to every model.



L32LRV



L31HRV

FEATURES

- SAE Class 1 Certified (Amber)
- High and low-dome models
- Smooth polycarbonate dome
- Powder-coated die-cast base
- Conformal coated electronics
- Dynamic Variable Intensity™ (DVI™) light patterns (12 VDC models only)

Model	Description
L31H*F	Permanent Mount, High Dome, Amber, Blue, White, Green or Red
L31HPF	Permanent Mount, High Dome, Amber/Green
L31H*M	Magnetic Mount, High Dome, Amber, Blue, White, Green or Red
L31H*V	Magnetic/Suction Mount, High Dome, Amber, Blue, White, Green or Red
L31H*F4	Permanent Mount, High Dome, Amber, Blue, White, Green or Red
L32L*F	Permanent Mount, Low Dome, Amber, Blue, White, Green or Red
L32L*M	Magnetic Mount, Low Dome, Amber, Blue, White, Green or Red
L32L*V	Magnetic/Suction Mount, Low Dome, Amber, Blue, White, Green or Red
L32L*F4	Permanent Mount, Low Dome, Amber, Blue, White or Red
L31HRFN	Permanent Mount, High Dome, Red, Meets NFPA Zone C Upper Requirements

Consult current price list for full list of available options at whelen.com/literature
 Replace * symbol in model number with letter indicating color desired: A = Amber, B = Blue, C = White, G = Green, R = Red
 To order Clear lenses add corresponding number to the end of model number 1 = A, 2 = B, 4 = G, 5 = R



DIMENSIONS

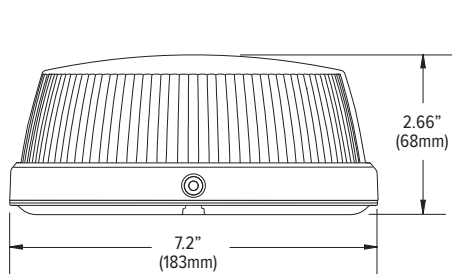

L32 Series

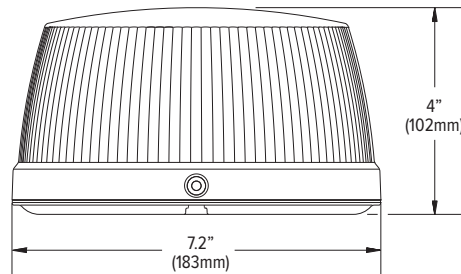

L31 Series

WHITE ILLUMINATION



WorkSide™



Features available across product family.
May not apply to every model.



WSLC

FEATURES

- Light is projected down and out to a 10'x10' ground area for increased visibility and expanded view of work areas
- Sleek, low-profile footprint
- Patented E Block™ technology prevents air and moisture from entering the lighthouse
- Selectable turn-on functionality
- Multiple turn-on styles ranging from instant to gradual (Slow, Medium, Fast, Instant)
- 3 low-power settings provide situation-specific lighting for a variety of scenarios
- Hard-coated lenses resist environmental damage from sand, sun, salt, and road chemicals
- Low power and low current consumption

Model	Flange	Lens Color	VDC
WSLC	Chrome	Clear	10-30
WSLB	Black		

Consult current price list for full list of available options at whelen.com/literature



DIMENSIONS

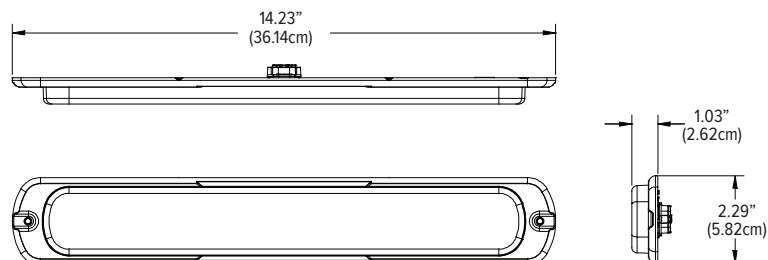

⚠ WARNING: This product may contain chemicals known to the State of California to cause cancer and birth defects or other reproductive harm. For more information, visit whelen.com/regulatory.

FIELD SERIES®



Field Series® Brow Light



Features available across product family.
May not apply to every model.

Design and build custom
vehicle setups with
Illumination Designer



FSB02B



FSB05B

FEATURES

- Up to 13 lightheads per power supply in multiple configurations
- Field serviceable
- 10-30 VDC
- 8 total inputs
- Low current switching
- Variable power distribution
- Extruded aluminum Black or White powder-coated housing
- Hard-coated lenses resist environmental damage from sand, sun, salt, and road chemicals
- Scan-Lock™ capability for light ramp, power, and markers

Stand Alone Model	Interconnect Model	Length	Number of Lightheads
FSB02B	FSB02MB	13.8 in (35.1cm)	2-Lightheads
FSB03B	FSB03MB	20 in (50.8cm)	3-Lightheads
FSB04B	FSB04MB	26.1 in (66.3cm)	4-Lightheads
FSB05B	FSB05MB	32.2 in (81.8cm)	5-Lightheads
FSB06B	FSB06MB	38.4 in (97.5cm)	6-Lightheads
FSB07B	FSB07MB	44.5 in (113.1cm)	7-Lightheads
FSB08B	FSB08MB	50.6 in (128.9cm)	8-Lightheads
FSB09B	FSB09MB	56.7 in (144.1cm)	9-Lightheads
FSB10B	FSB10MB	62.9 in (159.8cm)	10-Lightheads
FSB11B	FSB11MB	69 in (175.3cm)	11-Lightheads
FSB12B		75.1 in (190.8cm)	12-Lightheads
FSB13B		81.3 in (206.5cm)	13-Lightheads

○ Replace the Last "B" in the Model Number with "W" for a White Housing
Consult current price list for full list of available options at whelen.com/literature.

Field Series® Brow Light

Strip-Lite™ Plus
XL Tank Light

Traffic Advisor™ Flat Mount

OPTIONS

Model	Description
FSBNFC	Combination Near/Far Field Lighthouse, No Charge When Purchased with a FSB Array
FSBPS	Power Supply for up to 13 Lighthouses Total, with Scan-Lock™ Lighting Features and Low Power
FSBPC10	10' (3.05m) Power Supply Input Harness
FSBPC25	15' (4.57m) Power Supply Input Harness
FSBPC50	50' (15.24m) Power Supply Input Harness
FSBPC75	75' (22.86m) Power Supply Input Harness
FSBCC1	1' (30.48cm) Interconnect Cable for Use with Two or Three Field Series® Brow Light Arrays, One Required for Two Light Array Solution and Two Required for Three Light Array Solutions, No Charge When Purchasing FSBPS
FSBCC2	2' (60.96cm) Interconnect Cable for Use with Two or Three Field Series Brow Light Arrays, One Required for Two Light Array Solution and Two Required for Three Light Array Solutions, No Charge When Purchasing FSBPS
FSBCC3	3' (91.44cm) Interconnect Cable for Use with Two or Three Field Series Brow Light Arrays, One Required for Two Light Array Solution and Two Required for Three Light Array Solutions, No Charge When Purchasing FSBPS
FSBCELR	Optional Left Rear Cable Exit, When Connecting Multiple Light Arrays, All Cable Exits Must Be on the Same Side
FSBUB	Universal Adjustable Bracket Kit, Black (Curved). 2 Kits Required for 2-6 Light Array, 3 Kits for 7-10, 4 Kits for 11-12, and 5 Kits for 13
FSBLPB	"L" Bracket Kit (Low-Profile), Black. 2 Kits Required for 2-6 Light Array, 3 Kits for 7-10, 4 Kits for 11-12, and 5 Kits for 13
FSBBB	Bail Bracket Kit (Pair), 1 Kit Required Per Light Array, Black. (Requires FSBCBB for 7-13 Light Arrays)
FSBCBB	Center Mounted Bracket Kit, Black. Required for 7 or More Light Arrays When Used with Bail Bracket. 7-10 Light Array Requires 1; 11-12 Light Array Requires 2; 13 Light Array Requires 3; When Not Using FSBBB Bail Bracket, 2 Kits Required for 2-6 Light Array; 3 Kits for 7-10; 4 Kits for 11-12; and 5 Kits for 13
FSBLBB	Lightbar Bracket Kit, Black. 2 Kits Required for 2-6 Light Array; 3 Kits for 7-10; 4 Kits for 11-12; and 5 Kits for 13

DIMENSIONS

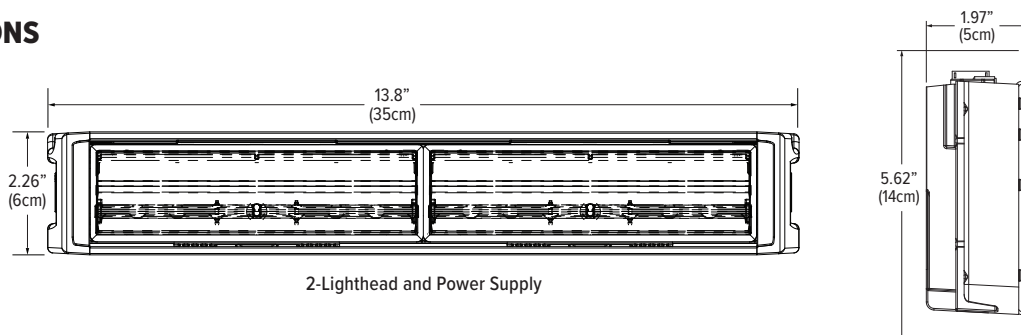

⚠ WARNING: This product may contain chemicals known to the State of California to cause cancer and birth defects or other reproductive harm. For more information, visit whelen.com/regulatory.

Arges® Remote Spotlight

2YR MOTOR ONLY 10YR 12 WE CAN X PROCLERA ProFocus.

Features available across product family. May not apply to every model.

ARGES®

FEATURES

- Innovative mechanical design provides 360° of continuous rotation and a 180° tilt range
- ProFocus™ Models: 5° spot to 60° flood variable beam width
- Spotlight Models: 5° spot
- Proclera® Silicone Optics
- Black die-cast aluminum housing
- WeCanX® compatible
- Drivetrain is electronically and mechanically protected
- Arges installs quickly and requires no A-pillar drilling or airbag interference
- Includes two 18" (45.72cm) power control harnesses and one 12" (30.48cm) communication cable
- Control head features a paddle and three push-buttons
- Program Arges with Whelen Command® or use alone with its paired control head
- Full Arges system passes CISPR 25 Class 3



DIMENSIONS

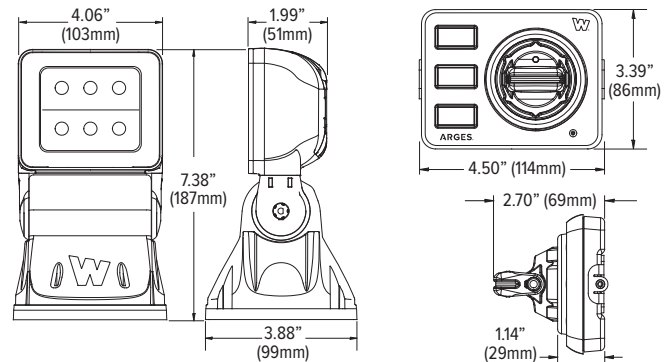

Model	Description
ARGES1	5° Spotlight with Proclera® Silicone Optic
ARGES2	ProFocus™, Select from Spot/Flood Combination Light or Floodlight from the Control Head
ARGFMKT	Arges Kit, Includes ARGES1 Spotlight, ARGCH1 Control Head and ARGFM Flat Mount
ARGCH1	Control Head for Arges, Bail Bracket
ARGCH2	Control Head for Arges, Swivel Mount
ARGFM	Flat Mount, Universal
ARG49D	2019-2024 Chevy Silverado 1500, Driver Side Fender Mount
ARG49P	2019-2024 Chevy Silverado 1500, Passenger Side Fender Mount
ARG49BD	2020-2025 Chevy Silverado 2500/3500, Driver Side Fender Mount
ARG54D	2021-2025 Chevy Tahoe, 2021-2025 Chevy Suburban, Driver Side Fender Mount
ARG54P	2021-2025 Chevy Tahoe, 2021-2025 Chevy Suburban, Passenger Side Fender Mount
ARG35D	2016-2023 Dodge Charger, Driver Side Fender Mount
ARG44AD	2015-2025 Dodge Durango, Driver Side Fender Mount
ARG44AP	2015-2025 Dodge Durango, Passenger Side Fender Mount
ARG42D	2019-2024 Ram 1500 (Classic), Driver Side Fender Mount
ARG53D	2020-2023 Ford Escape, Driver Side Fender Mount
ARG50D	2020-2025 Ford Police Interceptor Utility, Driver Side Fender Mount
ARG50P	2020-2025 Ford Police Interceptor Utility, Passenger Side Fender Mount
ARG47CD	2021-2024 Ford F-150 PPV, Driver Side Fender Mount

Model	Description
ARG47CP	2021-2024 Ford F-150 PPV, Passenger Side Fender Mount
ARG47BD	2019-2022 Ford F-250/F-350 and 2023-2024 Ford F-450/F-550 Super Duty, Driver Side Fender Mount
ARG47BP	2019-2022 Ford F-250/F-350 and 2023-2024 Ford F-450/F-550 Super Duty, Passenger Side Fender Mount
ARG47DD	2023-2025 Ford F-250/F-350 and Ford F-550/F-600 Super Duty, Driver Side Fender Mount
ARG47DP	2023-2025 Ford F-250/F-350 and Ford F-550/F-600 Super Duty, Passenger Side Fender Mount
ARG47ED	2022-2024 Ford F-150 Lightning, Driver Side Fender Mount
ARG47EP	2022-2024 Ford F-150 Lightning, Passenger Side Fender Mount
ARG48D	2019-2024 Ford Expedition, Driver Side Fender Mount
ARG57D	2021-2024 Ford Mach-E, Driver Side Fender Mount
ARG57P	2021-2024 Ford Mach-E, Passenger Side Fender Mount
ARG56D	2021-2022 Tesla Model Y, Driver Side Fender Mount
ARGMK1	2020-2025 Ford Police Interceptor Utility, Driver Side Arges Control Head Mount Kit
ARGLB1	Lightbar Mounting Bracket for Legacy®, Liberty™ II, Justice®, and Freedom® IV Series Lightbars, Arges with Flat Mount Purchased Separately
ARG59D	2024 Chevy Blazer EV PPV, Driver Side Fender Mount
ARG59P	2024 Chevy Blazer EV PPV, Passenger Side Fender Mount
ARG51D	2025 Ram 1500 SSV and 2019-2024 Ram 1500 (not 'Classic' body style), Driver Side
ARG51P	2025 Ram 1500 SSV and 2019-2024 Ram 1500 (not 'Classic' body style), Passenger Side

Consult current price list for full list of available options at whelen.com/literature.

M9 EZ Scene Light™



Features available across product family. May not apply to every model.



M92SLB

Model	Flange	Lens Color	VDC
M92SLC	Chrome	Clear	12
M92SLB	Black		
M92SLC4	Chrome	Clear	24
M92SLB4	Black		



M6 EZ Scene Light™



Features available across product family. May not apply to every model.



M62SLC

Model	Flange	Lens Color	VDC
M62SLC	Chrome	Clear	10-30
M62SLB	Black		



FEATURES

- Hard-coated lenses resist environmental damage from sand, sun, salt, and road chemicals
- Conformal coated electronics for moisture and vibration resistance
- Gradient Opti-Scenelight™ technology enables efficient use of light
- Selectable turn-on functionality
- Multiple turn-on styles ranging from instant to gradual (Slow, Medium, Fast, Instant)
- 3 low-power settings provide situation-specific lighting for a variety of scenarios
- Surface mount via 2 screws for easy installation
- 6" (15.24cm) pigtail cable included

DIMENSIONS

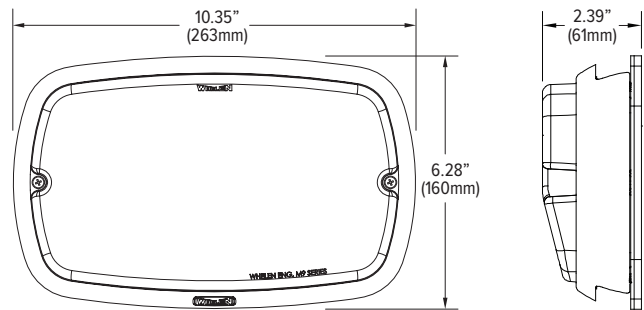

FEATURES

- Hard-coated lenses resist environmental damage from sand, sun, salt, and road chemicals
- Conformal coated electronics for moisture and vibration resistance
- Gradient Opti-Scenelight™ technology enables efficient use of light
- Selectable turn-on functionality
- Multiple turn-on styles ranging from instant to gradual (Slow, Medium, Fast, Instant)
- 3 low-power settings provide situation-specific lighting for a variety of scenarios
- Surface mount via 2 screws for easy installation
- 6" (15.24cm) pigtail cable included

DIMENSIONS

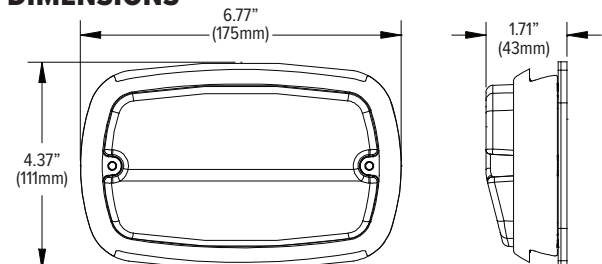

⚠ WARNING: This product may contain chemicals known to the State of California to cause cancer and birth defects or other reproductive harm. For more information, visit whelen.com/regulatory.

900 EZ Scene Light™



Features available across product family. May not apply to every model.

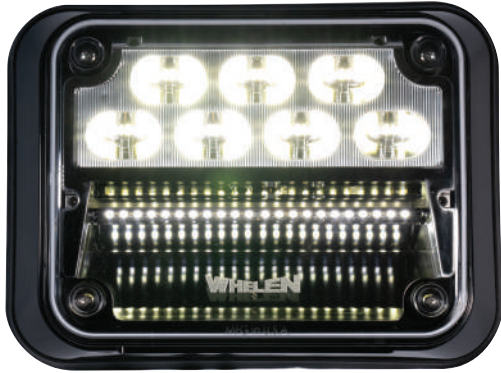

904SLB

Model	Flange	Lens Color	VDC
904SLC	Chrome	Clear	12
904SLB	Black		
904SLC4	Chrome	Clear	24
904SLB4	Black		



FEATURES

- Hard-coated lenses resist environmental damage from sand, sun, salt, and road chemicals
- Conformal coated electronics for moisture and vibration resistance
- Gradient Opti-Scenelight™ technology enables efficient use of light
- Selectable turn-on functionality
- Multiple turn-on styles ranging from instant to gradual (Slow, Medium, Fast, Instant)
- 3 low-power settings provide situation-specific lighting for a variety of scenarios
- Surface mount via 4 screws for easy installation
- 6" (15.24cm) pigtail cable included

DIMENSIONS

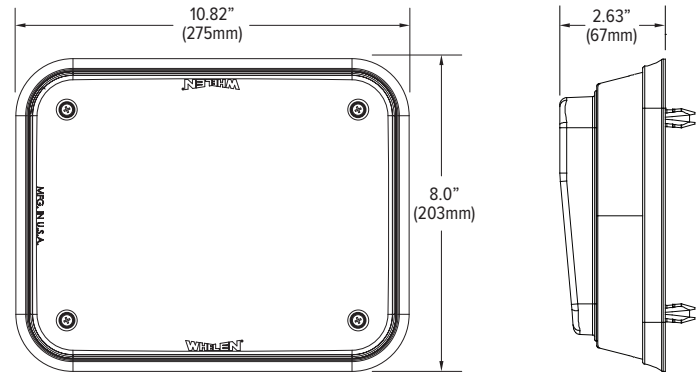

600 EZ Scene Light™



Features available across product family. May not apply to every model.



604SLB

Model	Flange	Lens Color	VDC
604SLC	Chrome	Clear	10-30
604SLB	Black		



FEATURES

- Hard-coated lenses resist environmental damage from sand, sun, salt, and road chemicals
- Conformal coated electronics for moisture and vibration resistance
- Gradient Opti-Scenelight™ technology enables efficient use of light
- Selectable turn-on functionality
- Multiple turn-on styles ranging from instant to gradual (Slow, Medium, Fast, Instant)
- 3 low-power settings provide situation-specific lighting for a variety of scenarios
- Surface mount via 4 screws for easy installation
- 6" (15.24cm) pigtail cable included

DIMENSIONS

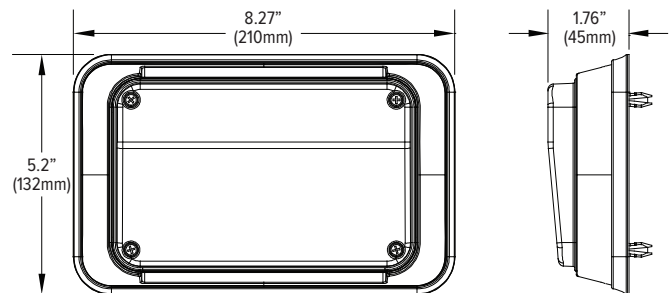

Pioneer Plus™



Download
Pioneer™ Designer for
models and options



Features available across product family. May not apply to every model.

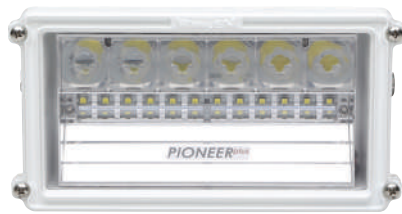

PFH1

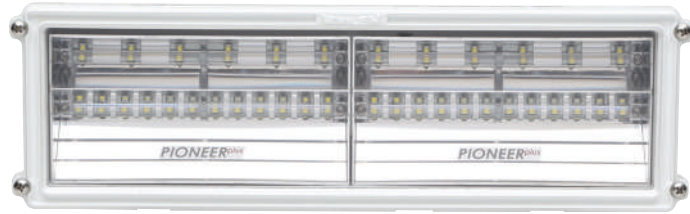

PFH2

FEATURES

- Single and dual models available
- Pioneer Plus Combination Floodlight/Spotlight features Proclera® Optic Technology
- Injection molded polycarbonate lenses are impact resistant and hard-coated
- Die-cast aluminum powder-coated housing in Black or White
- LEDs are instant On/Off, eliminating high inrush current and ramp-up time
- Correlated Color Temperature (CCT) of 5,700° Kelvin simulates bright midday light
- Powder-coated stainless steel bail bracket
- DC models includes 20' (6.10m) cable, AC models include 6" (15.24cm) wire leads, custom cable lengths available

Model	Description
PFH1	Single Panel Floodlight
PCH1	Single Panel Combination Flood/Spotlight
PFH2	Dual Panel Floodlight
PCH2	Dual Panel Combination Flood/Spotlight
PFP1AC	Single Panel Floodlight, 115 VAC
PSP1AC	Single Panel, Spotlight, 8°, 115 VAC
PFP2AC	Dual Panel Floodlight, 115 VAC
PCP2AFS	Dual Panel, Combination Flood/Spotlight, 115 VAC
PCP2ASF	Dual Panel, Combination Flood/Spotlight, 115 VAC
PCP3	Max Combination Flood and 8° Spotlight, 12 VDC
PCP3A	Max Combination Flood and 8° Spotlight, 115 VAC

Consult current price list for full list of available options at whelen.com/literature



DIMENSIONS

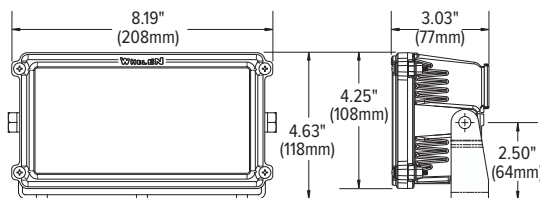

Single Panel Floodlight

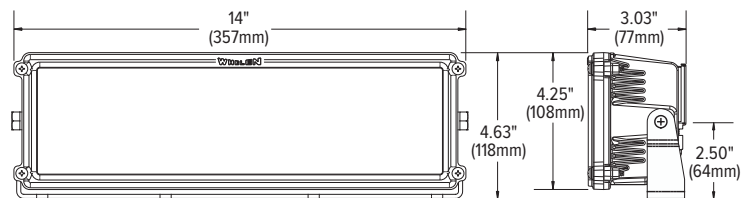

Double Panel Floodlight

⚠ WARNING: This product may contain chemicals known to the State of California to cause cancer and birth defects or other reproductive harm. For more information, visit whelen.com/regulatory.

WHELEN
MANUFACTURED IN AMERICA

Pioneer Summit™ Brow Light and Pioneer Summit

5YR $\angle 12$ $\angle 24$ IP67 **HARD COAT** PROCLERA[®]

Features available across product family. May not apply to every model.

Download
Pioneer™ Designer for
models and options



S44MRW



S44MRB

FEATURES

- Preconfigured spot, flood, or scene optics
- Available with White illumination, Amber marker, and warning lights
- Warning lights require remote flasher, purchased separately
- Individual control of each set of optics
- Hard-coated lenses resist environmental damage from sand, sun, salt, and road chemicals
- Extruded and die-cast aluminum powder-coated housing available in Black or White
- Screwless lens retainer design provides a clean finish and the improved ability to adjust optic configuration
- Rear mounting track for flexible mounting configurations, bail bracket mount standard
- Includes 2' (60.96cm) cable, connector, and heat shrink tubing

Model	Length	Description
Pioneer Summit Brow Light		
S86MB	86"	Separate Control of Scene, Flood and Spot Lights, Built-In Amber Clearance and Identification Lights
S86MRB	(218.44cm)	Separate Control of Scene, Flood and Four Red Warning Lights, Built-In Amber Clearance and Identification Lights
S72MB	72"	Separate Control of Scene, Flood and Spot Lights, Built-In Amber Clearance and Identification Lights
S72MRB	(182.88cm)	Separate Control of Scene, Flood and Four Red Warning Lights, Built-In Amber Clearance and Identification Lights
S58MB	58"	Separate Control of Scene, Flood and Spot Lights, Built-In Amber Clearance and Identification Lights
S58MRB	(147.32cm)	Separate Control of Scene, Flood and Four Red Warning Lights, Built-In Amber Clearance and Identification Lights
Pioneer Summit		
S44MB	44"	Separate Control of Scene, Flood and Spot Lights, Built-In Amber Identification Lights
S44MRB	(111.76cm)	Separate Control of Scene, Flood and Two Red Warning Lights, Built-In Amber Identification Lights
S30MB	30"	Separate Control of Scene, Flood and Spot Lights, Built-In Amber Identification Lights
S30MRB	(76.20cm)	Separate Control of Scene, Flood and Two Red Warning Lights, Built-In Amber Identification Lights
S161MB	16"	Wide Flood Light with Built-In Amber Clearance Light
S162MB	(40.64cm)	Spot Light with Built-In Amber Clearance Light
S091MB	9"	Wide Flood Light with Built-In Amber Clearance Light
S092MB	(22.86cm)	Spot Light with Built-In Amber Clearance Light



DIMENSIONS

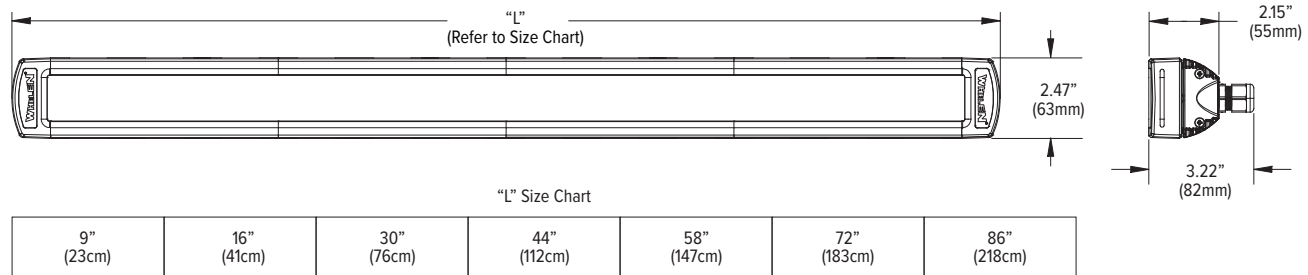

Pioneer Plus™ Surface Mount



Features available across product family. May not apply to every model.

Download
Pioneer™ Designer for
models and options



PCPSM2B



PCPSM1C

FEATURES

- Single and dual models available
- Injection molded polycarbonate lenses are impact resistant and hard-coated
- Aluminum heat plate in Black or White
- LEDs are instant On/Off, eliminating high inrush current and ramp-up time
- Correlated Color Temperature (CCT) of 5,700° Kelvin simulates bright midday light
- 6' (1.83m) to 2' (60.96cm) cable included
- Surface mount:
 - Requires no body cut-outs
 - Built-in nylon screw grommets eliminate galvanic corrosion
 - Uniquely designed silicone grommet seals the 1" (25mm) wire entry into the body
- Black or Chrome flange available

Model	Description
PCPSM1C	Single Panel, Combination Flood/Spot, Chrome Flange
PCPSM1B	Single Panel, Combination Flood/Spot, Black Flange
PCPSM1AC	Single Panel, Combination Flood/Spot, 115 VAC, Chrome Flange
PCPSM1AB	Single Panel, Combination Flood/Spot, 115 VAC, Black Flange
PCPSM2C	Dual Panel, Combination Flood/Spot, Chrome Flange
PCPSM2B	Dual Panel, Combination Flood/Spot, Black Flange
PCPSM2AC	Dual Panel, Combination Flood/Spot, 115 VAC, Chrome Flange
PCPSM2AB	Dual Panel, Combination Flood/Spot, 115 VAC, Black Flange



DIMENSIONS

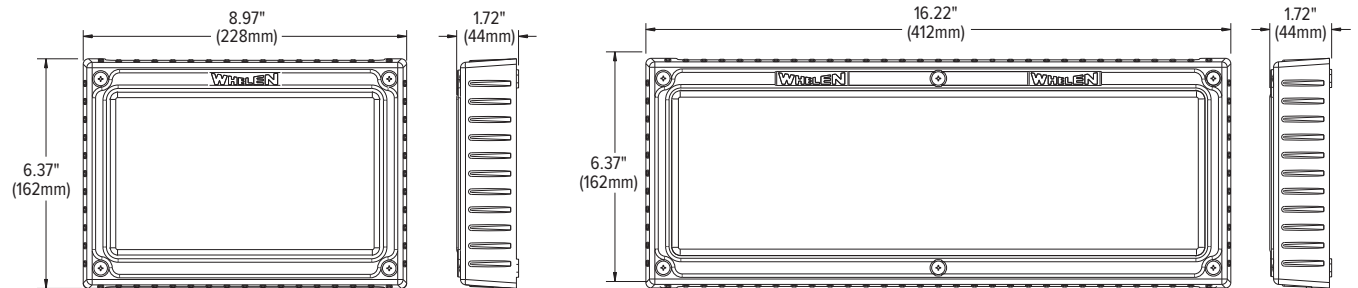

Single Panel Combo

Double Panel Combo

⚠ WARNING: This product may contain chemicals known to the State of California to cause cancer and birth defects or other reproductive harm. For more information, visit whelen.com/regulatory.

Pioneer SlimLine™



Features available across product family.
May not apply to every model.

Download
Pioneer™ Designer for
models and options



PSL1BB



PSL2PB

FEATURES

- Single or dual models available
- Single Lamp Models: 8° spotlight pattern comes standard
 - Includes additional 40° x 20° flood lens
- Dual Lamp Models: 8° spotlight pattern comes standard
- Includes two additional optic lenses for a light pattern choice of:
 - Dual 40° x 20° flood
 - 8° spot and 40° x 20° flood
- Optic lens changes easily via removable lens retainer
- Injection molded polycarbonate lenses are impact resistant
- Die-cast aluminum powder-coated housing in Black or White
- LEDs are instant On/Off, eliminating high inrush current and ramp-up time
- Correlated Color Temperature (CCT) of 5,700° Kelvin simulates bright midday light
- 6' (1.83m) cable included
- Powder-coated stainless steel bail bracket
- Hard-coated lenses resist environmental damage from sand, sun, salt, and road chemicals

Model	Description
PSL1B	Single Panel, Bail/Stud Mount, White Housing
PSL1BB	Single Panel, Bail/Stud Mount, Black Housing
PSL1P	Single Panel, Low-Profile Pedestal/Swivel Mount, White Housing
PSL1PB	Single Panel, Low-Profile Pedestal/Swivel Mount, Black Housing
PSL1R	Single Panel, Semi-Recessed Chrome Flange Mount, White Housing
PSL1RB	Single Panel, Semi-Recessed Chrome Flange Mount, Black Housing
PSL1R5	Single Panel, Semi-Recessed 15° Angle Chrome Flange Mount, White Housing
PSL1R5B	Single Panel, Semi-Recessed 15° Angle Chrome Flange Mount, Black Housing
PSL2B	Dual Panel, Bail/Stud Mount, White Housing
PSL2BB	Dual Panel, Bail/Stud Mount, Black Housing
PSL2P	Dual Panel, Low-Profile Pedestal/Swivel Mount, White Housing
PSL2PB	Dual Panel, Low-Profile Pedestal/Swivel Mount, Black Housing
PSL2R	Dual Panel, Semi-Recessed Chrome Flange Mount, White Housing
PSL2RB	Dual Panel, Semi-Recessed Chrome Flange Mount, Black Housing
PSL2R5	Dual Panel, Semi-Recessed 15° Angle Chrome Flange Mount, White Housing
PSL2R5B	Dual Panel, Semi-Recessed 15° Angle Chrome Flange Mount, Black Housing

Consult current price list for full list of available options at whelen.com/literature



DIMENSIONS

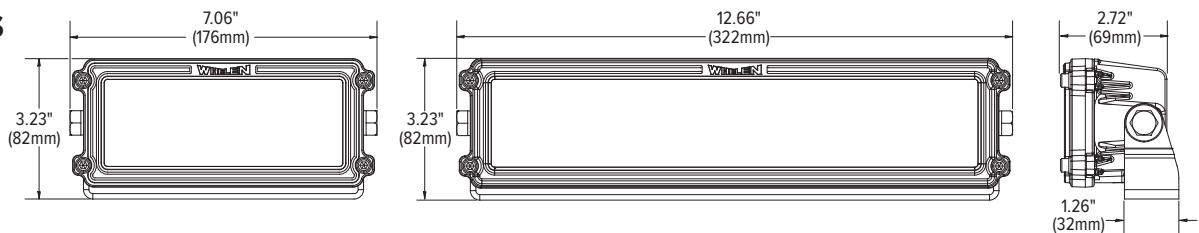

Pioneer Micro™



Features available across product family.
May not apply to every model.

Download
Pioneer™ Designer for
models and options



FEATURES

- 8° spotlight pattern comes standard. Includes three additional optic lenses for a light pattern choice of:
 - 90° x 20° wide flood
 - 40° x 20° standard flood
 - 40° x 8° narrow flood
- Optic lens changes easily via removable lens retainer
- Injection molded polycarbonate lenses are impact resistant
- Die-cast aluminum powder-coated housing in Black or White
- LEDs are instant On/Off, eliminating high inrush current and ramp-up time
- Correlated Color Temperature (CCT) of 5,700° Kelvin simulates bright midday light
- Hard-coated lenses resist environmental damage from sand, sun, salt, and road chemicals
- 6' (1.83m) cable included
- Five mounts available:
 1. Powder-coated stainless steel bail bracket with 3/8"-16 stud carriage bolt mount
 2. Recessed 90° angle mount with Chrome or Black flange
 3. Recessed 15° angle mount with Chrome or Black flange
 4. Pole/pedestal mount with handle available with or without On/Off switch
 5. Low-profile pedestal mount available with Chrome or Black back cover, with or without On/Off switch

Model	Description
MPBW	Bail/Stud Mount, White Housing
MPBB	Bail/Stud Mount, Black Housing
MPPW	Low-Profile Pedestal/Swivel Mount, White Housing
MPPB	Low-Profile Pedestal/Swivel Mount, Black Housing
MPPWCS	Low-Profile Pedestal/Swivel Mount, White Housing, Chrome Cover and On/Off Switch
MPPBBS	Low-Profile Pedestal/Swivel Mount, Black Housing and On/Off Switch
MPPBCS	Low-Profile Pedestal/Swivel Mount, Black Housing, Chrome Cover and On/Off Switch
MPRW	Straight Recessed Mount, White Housing, Chrome Flange
MPRB	Straight Recessed Mount, Black Housing, Chrome Flange
MPRBB	Straight Recessed Mount, Black Housing, Black Flange
MPR15W	15° Recessed Mount, White Housing

Consult current price list for full list of available options at whelen.com/literature



DIMENSIONS

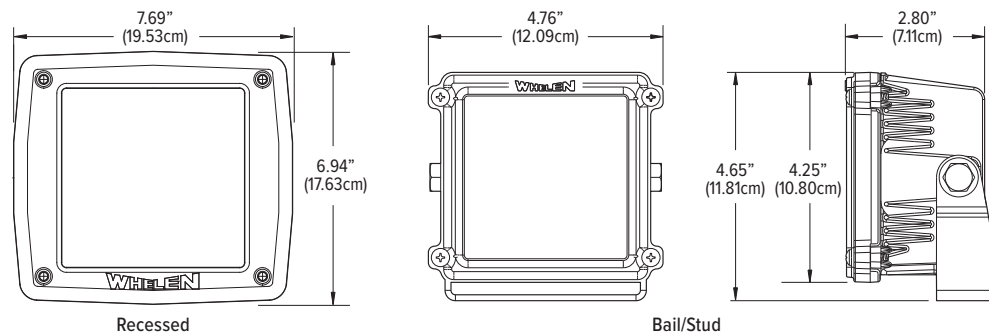

⚠ WARNING: This product may contain chemicals known to the State of California to cause cancer and birth defects or other reproductive harm. For more information, visit whelen.com/regulatory.

Pioneer Nano™



Features available across product family.
May not apply to every model.

Download
Pioneer™ Designer for
models and options



NP3BW



NP6BB

FEATURES

- 8° spotlight pattern comes standard. Includes additional optic lens for a light pattern of:
 - 40° x 20° flood
- Optic lens changes easily via removable lens retainer
- Injection molded polycarbonate lenses are impact resistant
- Die-cast aluminum powder-coated housing in Black or White

- LEDs are instant On/Off, eliminating high inrush current and ramp-up time
- Correlated Color Temperature (CCT) of 5,700° Kelvin simulates bright midday light
- Includes 6' (1.83m) cable
- Powder-coated stainless steel bail bracket with 1/4"-22 stud carriage bolt mount

Model	Description
NP3BW	3-LED, Bail Mount, White Housing
NP3BB	3-LED, Bail Mount, Black Housing
NP6BW	6-LED, Bail Mount, White Housing
NP6BB	6-LED, Bail Mount, Black Housing

Consult current price list for full list of available options at whelen.com/literature



DIMENSIONS

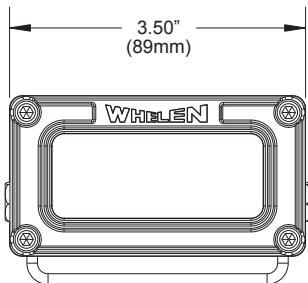

NP3BW 3-LED

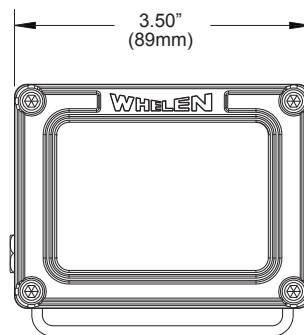
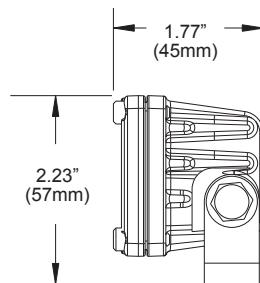

NP6BW 6-LED

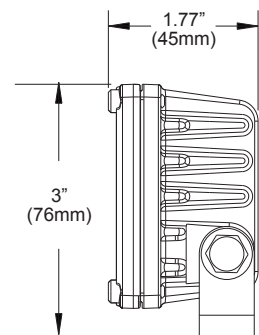

Scene Lights



Features available across product family. May not apply to every model.

PEL2



M9LZC

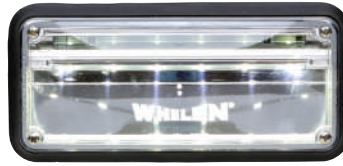

7SCOENZR



PEL2B



70COELZR



M6ZC



9SCOENZR



M7ZC



6SCOENZR

FEATURES

- Instant On with no warm-up time
- Hard-coated lenses resist environmental damage from sand, sun, salt, and road chemicals

Model	Description
6SCOENZR	600 Series, Surface Mount
60COELZR	600 Series, Recessed Mount
7SCOENZR	700 Series, Surface Mount
70COELZR	700 Series, Recessed Mount
9SCOENZR	900 Series, Surface Mount, Includes Chrome Flange
9SBOENZR	900 Series, Surface Mount, Includes Black Flange
PEL2C	PEL Series, Ground Perimeter Light, Surface Mount, Includes Chrome Flange
PEL2B	PEL Series, Ground Perimeter Light, Surface Mount, Includes Black Flange
M6ZC	M6 Series, Surface Mount
M7ZC	M7 Series, Surface Mount
M9LZC	M9 Series, Surface Mount, Includes Chrome Flange
M9LZB	M9 Series, Surface Mount, Includes Black Flange

Consult current price list for full list of available options at whelen.com/literature

See model-specific pages for dimensions



⚠ WARNING: This product may contain chemicals known to the State of California to cause cancer and birth defects or other reproductive harm. For more information, visit whelen.com/regulatory.

Interior Lights



Features available across product family.
May not apply to every model.



86CE1



5GCOCCCR + 5GFLANGC



PSCOMPL



PSCOMPH + PSFC



20COCD CR + 2GFLANGC



TOCACCCR + TFLANGEB



F27PC

Model	Description
86CE1	Rectangular Interior Dome Super-LED®, White
TOCACCCR	2" (5.08cm) Round 5mm LED Compartment Light, White
20COCD CR	2G Series, Super-LED (4" Round) Compartment Light, 12 Diodes, White
20COCD CD	2G Series, Super-LED (4" Round) Compartment Light, with Deutsch® Connector, Twelve Diodes, White
5GCOCCCR	5G Series, Super-LED Compartment Light, White
F09PC	Fluorent Plus™ Super-LED 9" (22.86 cm) Compartment Tube Lighting, White
F18PC	Fluorent Plus Super-LED 18" (45.72 cm) Compartment Tube Lighting, White
F27PC	Fluorent Plus Super-LED 27" (68.58 cm) Compartment Tube Lighting, White
F36PC	Fluorent Plus Super-LED 36" (91.44 cm) Compartment Tube Lighting, White
F45PC	Fluorent Plus Super-LED 45" (114.30 cm) Compartment Tube Lighting, White
F54PC	Fluorent Plus Super-LED 54" (137.16 cm) Compartment Tube Lighting, White
F63PC	Fluorent Plus Super-LED 63" (160.02 cm) Compartment Tube Lighting, White
PSCOMPL	Strip-Lite™ Plus Surface Mount Super-LED Compartment Light, Low Intensity
PSCOMPH	Strip-Lite Plus Surface Mount Super-LED Compartment Light, High Intensity

Consult current price list for full list of available options at whelen.com/literature

See model-specific pages for dimensions



Interior Lights



Features available across product family.
May not apply to every model.



70CREGCS (Shown in White)

70CREGCS (Shown in Red)



8" Round Lighthouses



6" Round Lighthouses



3" Round Lighthouses

Model	Description
3SC0CD CR	3" (7.62cm) Round LED, Compartment Light, White
3SR0CD RR	3" (7.62cm) Round LED, Nighttime Illumination, Red
3SBCCDCR	3" (7.62cm) Round LED, Compartment Light, Split Blue/White
3SRCCDCR	3" (7.62cm) Round LED, Compartment Light, Split Red/White
60COEHCR	6" (15.24cm) Round Super-LED®, Compartment Light, 18 White Diodes
60COEJCS	6" (15.24cm) Round Super-LED, Compartment Light, Six White Diodes
60CBEGCS	6" (15.24cm) Round Super-LED, Compartment Light, Six Blue Diodes and 6 White Diodes
60CREGCS	6" (15.24cm) Round Super-LED, Compartment Light, Six Red Diodes and 6 White Diodes
70CREGCS	700 Series, Compartment Light, 30 Red Diodes and 30 White Diodes
80COEHCR	8" (20.32cm) Round Super-LED Ambulance Light, Eighteen White Diodes
80COEHCA	8" (20.32cm) Round Super-LED Ambulance Light, Eighteen White Diodes, AMP connector
80COOEZR	8" (20.32cm) Round Super-LED Ambulance Light, Eighteen White Diodes
8WCOOEZR	8" (20.32cm) Round Super-LED Ambulance Light, Eighteen White Diodes
80CBEHCR	8" (20.32cm) Round Super-LED Ambulance Light, Six White Diodes and Three Blue Diodes
80CREHCR	8" (20.32cm) Round Super-LED Ambulance Light, Six White Diodes and Three Red Diodes

Consult current price list for full list of available options at whelen.com/literature

See model-specific pages for dimensions



⚠ WARNING: This product may contain chemicals known to the State of California to cause cancer and birth defects or other reproductive harm. For more information, visit whelen.com/regulatory.

Rubber Housing Spot/Floodlights



Features available across product family.
May not apply to every model.

FEATURES

- Rubber stud/swivel housing
- Available with or without lighthead
- Durable TPE housing resists cracking
- Hard-coated lenses resist environmental damage from sand, sun, salt, and road chemicals

Model	Description
P36SLCHG	PAR-36, Combination Spotlight/Floodlight
P46SLCHG	PAR-46, Spotlight

Consult current price list for full list of available options at whelen.com/literature



P36SLCHG

P46SLCHG

DIMENSIONS

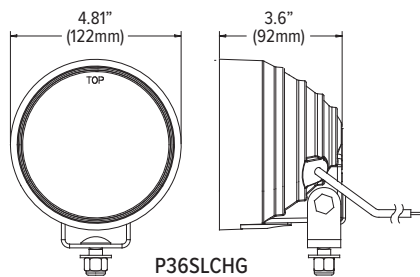

P36SLCHG

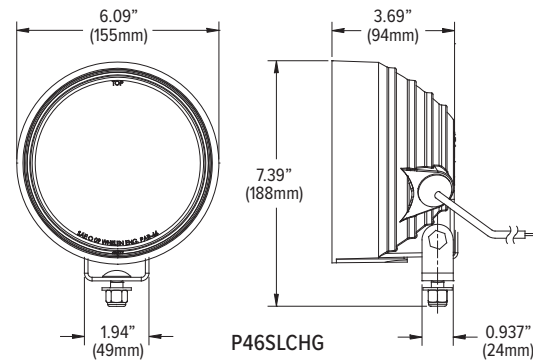

P46SLCHG

Handheld Spot/Floodlights



Features available across product family.
May not apply to every model.

FEATURES

- 90lb pull magnet mount with 8' coiled cord and cigar plug
- Built-in push-button On/Off switch
- Durable TPE housing resists cracking
- Hard-coated lenses resist environmental damage from sand, sun, salt, and road chemicals

Model	Description
P36HHS	PAR-36, Super-LED® Handheld Combination Spotlight/Floodlight
P46HHS	PAR-46, Super-LED Handheld Spotlight

Consult current price list for full list of available options at whelen.com/literature



P36HHS

P46HHS

PAR-36 & PAR-46



Features available across product family.
May not apply to every model.

FEATURES

- Floodlight or spotlight models
- Black die-cast aluminum housing
- Hard-coated lenses resist environmental damage from sand, sun, salt, and road chemicals
- Indexing locking lever on pedestal swivel
- Super-LED® with low current draw
- Stainless steel bracket and hardware included
- Two intensities available



PFBS12

Model	Description
PFBP12	Twelve Super-LED Floodlight, Black Housing
PFBP12C	Twelve Super-LED Floodlight, Black Housing, Chrome Rear Cover
PFBP6	Six Super-LED Floodlight, Black Housing
PFBP6C	Six Super-LED Floodlight, Black Housing, Chrome Rear Cover
PFBS12	Twelve Super-LED Floodlight, Black Housing
PFBS12C	Twelve Super-LED Floodlight, Black Housing, Chrome Rear Cover
PFBS6	Six Super-LED Floodlight, Black Housing
PFBS6C	Six Super-LED Floodlight, Black Housing, Chrome Rear Cover
PFBS6S	Six Super-LED Floodlight, Black Housing, Switch
PFBS12S	Twelve Super-LED Floodlight, Black Housing, Switch
PSBP12	Twelve Super-LED Spotlight, Black Housing
PSBP12C	Twelve Super-LED Spotlight, Black Housing, Chrome Rear Cover
PSBP6	Six Super-LED Spotlight, Black Housing
PSBP6C	Six Super-LED Spotlight, Black Housing, Chrome Rear Cover
PSBS12	Twelve Super-LED Spotlight, Black Housing
PSBS12C	Twelve Super-LED Spotlight, Black Housing, Chrome Rear Cover
PSBS6	Six Super-LED Spotlight, Black Housing
PSBS6C	Six Super-LED Spotlight, Black Housing, Chrome Rear Cover
PSBS6S	Six Super-LED Spotlight, Black Housing, Switch
PSBS12S	Twelve Super-LED Spotlight, Black Housing, Switch

DIMENSIONS

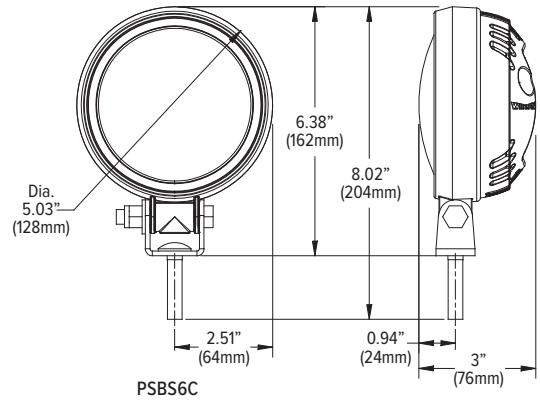

PSBS6C

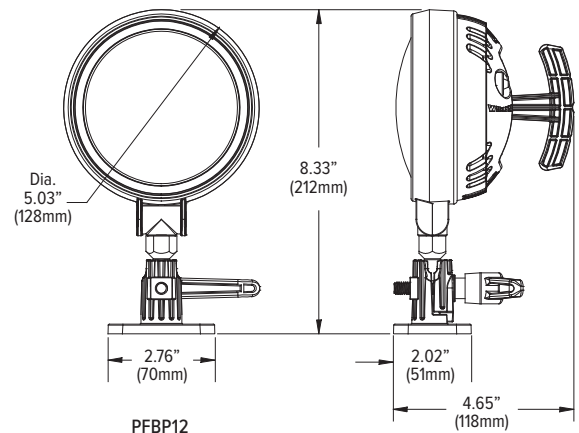

PFBP12

Consult current price list for full list of available options at whelen.com/literature



⚠ WARNING: This product may contain chemicals known to the State of California to cause cancer and birth defects or other reproductive harm. For more information, visit whelen.com/regulatory.

PAR Replacement Lamps



Features available across product family. May not apply to every model.



P46S2R



P46FLC



P46WLC



P46SLC



P36SLC

FEATURES

- Hard-coated lenses resist environmental damage from sand, sun, salt, and road chemicals
- Clear or Smoked lenses available

Model	Description
P46SC	PAR-46 Replacement, 2° Spotlight (Replaces P46SLC)
P46SCX	PAR-46 Replacement, 2° Spotlight, Smoked Lens (Replaces P46SLCX)
P46FLC	PAR-46 Super-LED, 8° Spotlight, White
P46FLCX	PAR-46 Super-LED, 8° Spotlight, with Smoked Lens, White
P46WLC	PAR-46 Super-LED, 20° x 60° Floodlight, White
P46WLCX	PAR-46 Super-LED, 20° x 60° Floodlight, with Smoked Lens, White
P46S2*	PAR-46 Super-LED, 8° Spotlight with Blue or Red Warning
P46S2X2	PAR-46 Super-LED, 8° Spotlight with California Steady Red
P46S2*3	PAR-46 Super-LED, 8° Spotlight with Blue or Red Warning
P36SLC	PAR-36 Super-LED, 2° Spotlight, White

Consult current price list for full list of available options at whelen.com/literature

Replace * symbol in model number with letter indicating color desired: B = Blue, C = White, R = Red



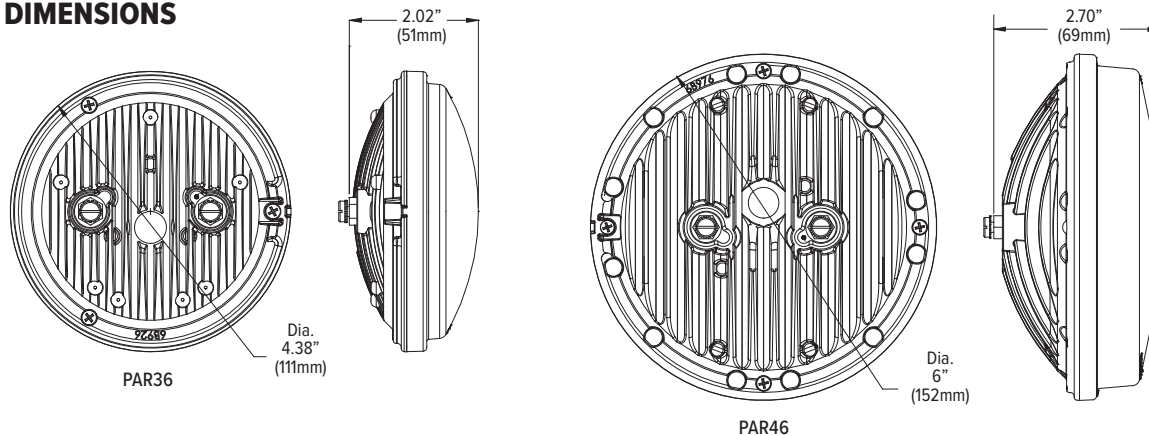

DIMENSIONS

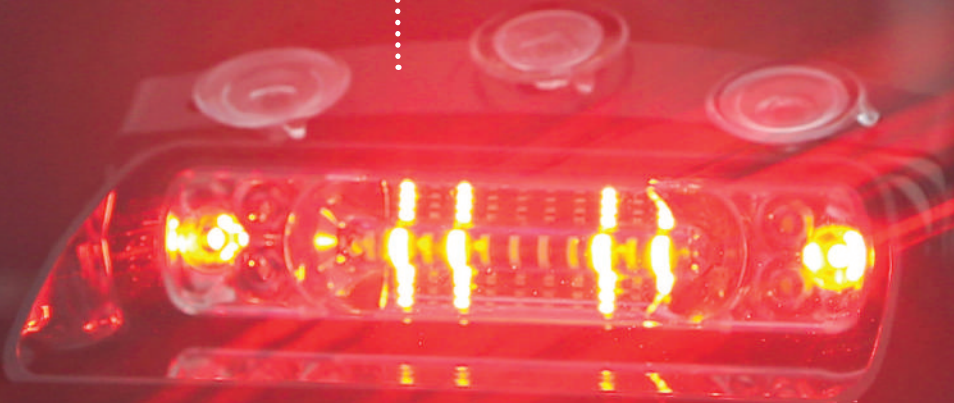

DASH & DECK

Avenger® II Series Single Lamp



 **WARNING:** This product may contain chemicals known to the State of California to cause cancer and birth defects or other reproductive harm. For more information, visit whelen.com/regulatory.

WHELEN
MANUFACTURED IN AMERICA

Avenger® II Series

5YR 12 TITLE 13 SAE CLASS 1 HARD COAT SCAN LOCK **SOLO™** **DUO™** **TRIO™**

Features available across product family. May not apply to every model.



FEATURES

- SAE Class 1 Certified
- Combination Linear/TIR™ optics
- SOLO™, DUO™ and TRIO™ models available
- Polycarbonate housing
- Conformal coated electronics
- Cigar plug series models include 10' (3.05m) cord with On/Off switch and Scan-Lock™ flash pattern switch
- Hard-wire series models include 2-wire (SOLO), 3-wire (DUO) or 4-wire (TRIO) pigtail

Model	Description
AVC11*	Single Lamp, SOLO, Amber, Blue, White, Green or Red
AVC21**	Dual Lamp, SOLO, Amber, Blue, White, Green and/or Red
AVC12#	Single Lamp, DUO, Red/White, Blue/White, Amber/White, Red/Blue, Red/Amber Blue/Amber or Amber/Green
AVC22DD	Dual Lamp, DUO, Two Red/White
AVC22DE	Dual Lamp, DUO, One Red/White, One Blue/White
AVC22EE	Dual Lamp, DUO, Two Blue/White
AVC22FF	Dual Lamp, DUO, Two Amber/White
AVC22JJ	Dual Lamp, DUO, Two Red/Blue
AVC22KK	Dual Lamp, DUO, Two Red/Amber
AVC22MM	Dual Lamp, DUO, Two Blue/Amber
AVC13RBC	Single Lamp, TRIO, Red/Blue/White
AVC13RBA	Single Lamp, TRIO, Red/Blue/Amber
AVC13RAC	Single Lamp, TRIO, Red/Amber/White
AVC13BAC	Single Lamp, TRIO, Blue/Amber/White

Model	Description
Cigar Plug Series	
AVC23RBC	Dual Lamp, TRIO, Red/Blue/White
AVC23RBA	Dual Lamp, TRIO, Red/Blue/Amber
AVC23RAC	Dual Lamp, TRIO, Red/Amber/White
AVC23BAC	Dual Lamp, TRIO, Blue/Amber/White
Hard-Wire Series	
AVW11*	Single Lamp, SOLO, Amber, Blue, White, Green or Red
AVW21**	Dual Lamp, SOLO, Amber, Blue, White, Green and/or Red
AVW12#	Single Lamp, DUO, Red/White, Blue/White, Amber/White, Red/Blue or Blue/Amber
AVW22DD	Dual Lamp, DUO, Two Red/White
AVW22DE	Dual Lamp, DUO, One Red/White and One Blue/White
AVW22EE	Dual Lamp, DUO, Two Blue/White
AVW22FF	Dual Lamp, DUO, Two Amber/White
AVW22HH	Dual Lamp, DUO, Two Green/White
AVW22JJ	Dual Lamp, DUO, Two Red/Blue
AVW22KK	Dual Lamp, DUO, Two Red/Amber
AVW22MM	Dual Lamp, DUO, Two Blue/Amber

Consult current price list for full list of available options at whelen.com/literature

Replace * symbol in model number with letter indicating color desired: A = Amber, B = Blue, C = White, G = Green, R = Red

Replace # in model number with interleaved color desired: D = Red/White, E = Blue/White, F = Amber/White, J = Red/Blue, K = Red/Amber, M = Blue/Amber, P = Amber/Green



DIMENSIONS

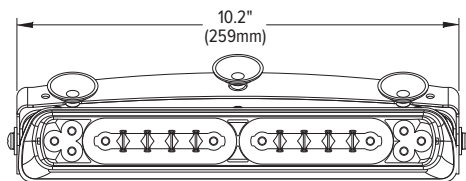

Avenger II Dual Series

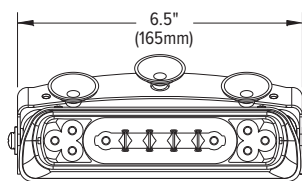

Avenger II Single Series

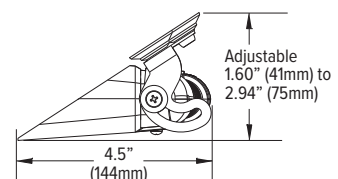

SlimLighter®



Features available across product family. May not apply to every model.



SLPMMRR

FEATURES

- Swivel bracket for permanent or suction cup mounting included
- Includes built-in pattern selection button, 10' (3.05m) straight cord with cigar plug and On/Off switch with LED "On" indicator

Model	Description
SLPMM**	Super-LED® Interior Light, Amber, Blue, White, Green and/or Red

Consult current price list for full list of available options at whelen.com/literature

Replace * symbol in model number with letter indicating color desired:
A = Amber, B = Blue, C = White, R = Red



DIMENSIONS

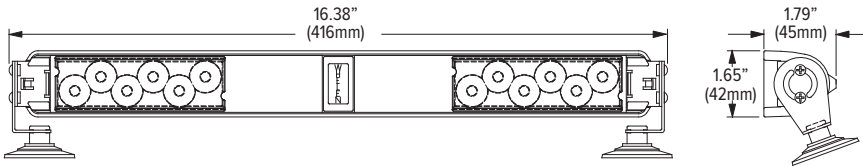

SpitFire® ION® Series



Features available across product family. May not apply to every model.

FEATURES

- Polycarbonate housing
- Conformal coated electronics
- Hard-coated lenses resist environmental damage from sand, sun, salt, and road chemicals
- Models include 10' (3.05m) cord with cigar plug with On/Off switch and Scan-Lock™ flash pattern switch



SFIONR

Model	Description
SFION*	Super-LED SpitFire ION Single Color, Amber, Blue, White, Green, or Red
SFION#	Super-LED SpitFire ION, Split-Color, Red/White, Blue/White, Amber/White, Red/Blue, Red/Amber, or Blue/Amber

Consult current price list for full list of available options at whelen.com/literature
Replace * symbol in model number: A = Amber, B = Blue, C = White, G = Green, R = Red
Replace # symbol in model number with letter indicating colors desired: D = Red/White, E = Blue/White, F = Amber/White, J = Red/Blue, K = Red/Amber, or M = Blue/Amber



DIMENSIONS

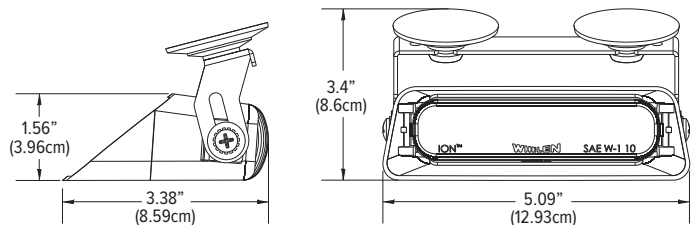

⚠ WARNING: This product may contain chemicals known to the State of California to cause cancer and birth defects or other reproductive harm. For more information, visit whelen.com/regulatory.

CONTROLS & SIRENS

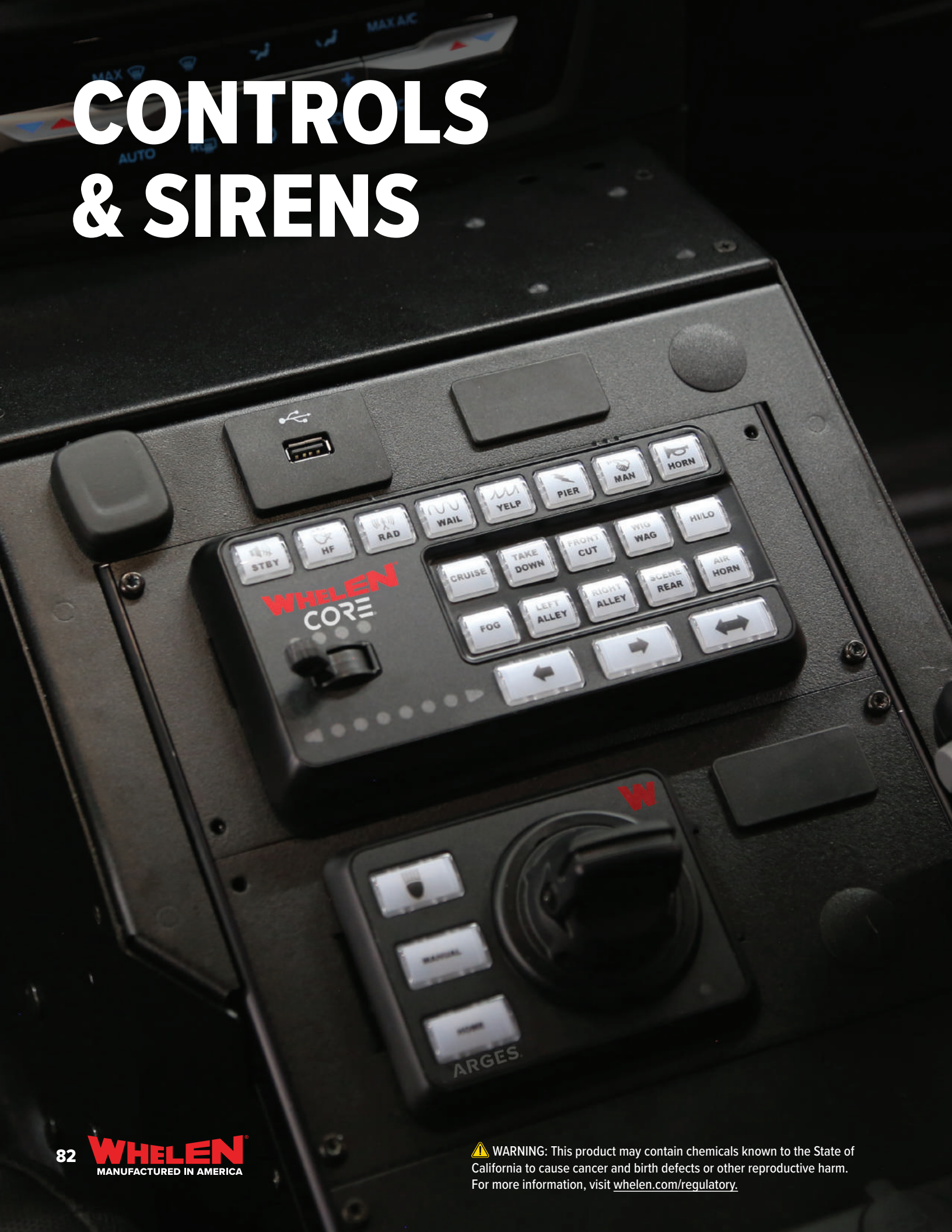

CenCom Core®



Features available across product family. May not apply to every model.

Created to enhance first responder safety, CenCom Core redefined control systems by providing the greatest configurability, speed, and expansion yet. Built to scale with your needs, Core® is highly configurable and offers advanced automation, remote connectivity, and true system synchronization.

FEATURES

- Powered by WeCanX®
- Supports any combination of up to 99 WeCanX devices
- Seamlessly integrates with Whelen Command® software
- Remote firmware updates through USB-C with Whelen Command or over-the-air with Whelen Cloud Platform®
- Vehicle-to-Vehicle Sync



DIMENSIONS

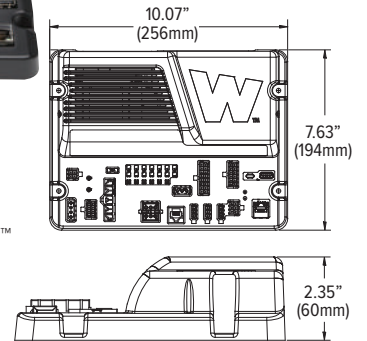

- Dynamic Variable Intensity™ light patterns
- 17 total inputs
- 23 total outputs

Core-S®



Features available across product family. May not apply to every model.

The newest addition to Whelen's industry-leading Core family of control systems, Core-S is a true one-box solution. Its space-saving design allows for installation in tight spaces like in a console or under a dash. And installation has never been easier with connector placement specifically designed for hard-to-reach areas. Core-S features a siren, input/output, and control functionality in one compact box along with multiple integrated control head options.

FEATURES

- Powered by WeCanX
- Seamlessly integrates with Whelen Command software
- Remote firmware updates through USB-C with Whelen Command or over-the-air with Whelen Cloud Platform
- Vehicle-to-Vehicle Sync



DIMENSIONS

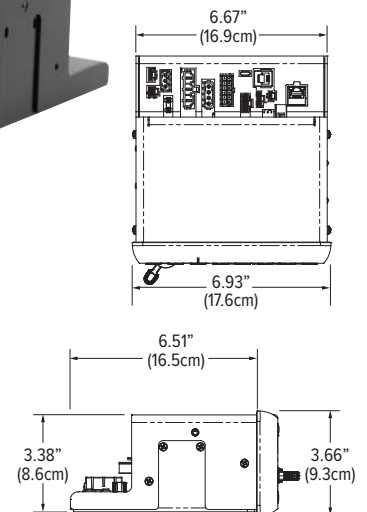

- Dynamic Variable Intensity light patterns
- 11 total inputs
- 16 total outputs

Core-R®



Features available across product family. May not apply to every model.

Core-R is a vehicle control system engineered to enhance first responder and motorist safety with complete configurability, advanced automation, and remote connectivity.

FEATURES

- Powered by WeCanX
- Supports any combination of up to 99 WeCanX devices
- Seamlessly integrates with Whelen Command software
- Remote firmware updates through USB-C with Whelen Command or over-the-air with Whelen Cloud Platform



DIMENSIONS

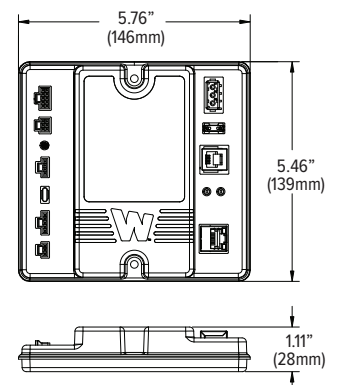

- Vehicle-to-Vehicle Sync
- Dynamic Variable Intensity light patterns
- 8 total inputs

⚠ WARNING: This product may contain chemicals known to the State of California to cause cancer and birth defects or other reproductive harm. For more information, visit whelen.com/regulatory.

WECANX® CONTROL SYSTEMS

C399	Core® 200-Watt Amplifier Control Module, Flashing Outputs, Includes 3 CANport™ Signals, and Controls up to 99 Devices/Remote Modules, Control Heads Purchased Separately
C399R	Core-R® Control Module, Includes 8 Digital Inputs, 3 CANport Signals and Controls up to 99 Device/Remote Modules, Control Head and Other Optional Modules Purchased Separately, 10-30 VDC
C399S	Core-S® 200-Watt Amplifier Control Module, Flashing Outputs, Includes 3 CANport Signals and Controls Up to 99 Devices/Remote Modules, Control Head and Other Modules Purchased Separately, 12 VDC
C399SH	Core-S 100-Watt Amplifier Control Module with 100-Watt Howler™, Flashing Outputs, Includes 3 CANport Signals and Controls Up to 99 Devices/Remote Modules, Control Head and Other Modules Purchased Separately, Single Howler Mounting Bracket (HSB#) Purchased Separately , 12 VDC
C399S6	Core-S Single Unit 200-Watt Siren with Integrated 3-Section Control Head and 8 Push-Buttons, 4-Position Slide Switch with a 7-Position Rotary Knob, Manual, Airhorn, Plus 3 Traffic Advisor™ Switches and Microphone with Extension Cable
C399S6H	Core-S Single Unit 100-Watt Siren and 100-Watt Howler with Integrated 3-Section Control Head and 8 Push-Buttons, 4-Position Slide Switch with a 7-Position Rotary Knob, Manual, Airhorn, Plus 3 Traffic Advisor Switches and Microphone with Extension Cable, Single Howler Mounting Bracket (HSB#) Purchased Separately , 12 VDC
C399S7	Core-S Single Unit 200-Watt Siren with Integrated 3-Section Control Head and 21 Push-Buttons, 4-Position Slide Switch, Microphone with Extension Cable
C399S7H	Core-S Single Unit 100-Watt Siren and 100-Watt Howler with Integrated 3-Section Control Head and 21 Push-Buttons, 4-Position Slide Switch, Microphone with Extension Cable, Single Howler Mounting Bracket (HSB#) Purchased Separately , 12VDC
C399S24	200-Watt Amplifier Control Module, Flashing Outputs, Includes 3 CANports and Controls Up to 99 Devices/Remote Modules, Control Head and Other Modules Purchased Separately, 24 VDC
CCP9	Core-C® Control Point and Switch Combination with 4-Position Slide Switch and 6 Push Buttons Plus One 5 amp Output for Auxiliary Lighting, LED TA Indicator, V2V Sync Capable, 10-30 VDC
CCPKT	Core Control Point for Use with WeCanX Devices when NOT Using CenCom Core® (For Use when not Purchasing a Lightbar)

WECANX CONTROL HEADS

CCTL5	Includes Handheld Combination Microphone and Controller, 5-Position Progressive Light/Siren Control, 9 Push-Buttons and a Microphone Extension Cable
CCTL6	Includes 3-Section Control Head and 8 Push-Buttons, 4-Position Slide Switch with a 7-Position Rotary Knob, Manual, Airhorn, Plus 3 Traffic Advisor Switches and Microphone with Extension Cable
CCTL7	Includes 3-Section Control Head and 21 Push-Buttons, 4-Position Slide Switch, Microphone with Extension Cable
CCTL8	Includes 6 Push-Buttons and a 4-Position Slide Switch, Includes Microphone
CCTL8LM	Includes 6 Push-Buttons and a 4-Position Slide Switch (Microphone Not Included)
CCTL9	Includes 2-Section Control Head and 6 Push-Buttons with a 7-Position Rotary Knob, Microphone and Microphone Extension Cable
CCTL9LM	Includes 2-Section Control Head and 6 Push-Buttons with a 7-Position Rotary Knob, (No Microphone or Microphone Extension Cable)
CCTL10	Includes 3-Section Control Head and 21 Push-Buttons, 1 Master Push-Button, Microphone with Extension Cable
CCTLHARN	CenCom Core Control Head Harness Kit, for Use with any Non-Primary Control Head Excluding the CCTL5, Control Heads Purchased Separately
CCTL11	Includes 3 Section Control Head and 13 Push-Buttons, Microphone with Extension Cable, Pre-labeled Control Buttons (Non-Changeable)
CCTL11LM	Includes 3 Section Control Head and 13 Push-Button (Microphone Not Included) , Pre-labeled Control Buttons (Non-Changeable)

SIREN AMPLIFIERS

CEXAMP	WeCanX External Amplifier
CHOWLER	Siren Amplifier with Two Speakers, Optional Vehicle Specific Mounting Brackets, No Charge When Purchased with Howler™ Siren
CHWLDC15	Siren Amplifier with One Speaker, Includes Mounting Bracket for 2015-2023 Dodge Charger
CHWLDD36	Siren Amplifier with One Speaker, Includes Mounting Bracket for 2021-2025 Dodge Durango
CHWLFE29	Siren Amplifier with One Speaker, Includes Mounting Bracket for 2020-2025 Ford Police Interceptor Utility
CHWLUNI	Siren Amplifier with One Speaker, Includes Universal Mounting Bracket

OBDII CANPORT™ INSTALLATION KITS FOR CORE®

C399K1	OBDII CANport™ Installation Kit for C399 for 2020-2022 Ford Interceptor Utility Used with Factory Option 61B, 2018-2022 Ford F-250/350, (Not for Use with Core-R® and C399S)
C399K2	OBDII CANport Installation Kit for C399 for 2019-2021 Chevy Colorado 1500 (Not for Use with Core-R and C399S)
C399K3	OBDII CANport Installation Kit for C399 for 2019-2024 Ram 1500, 2021-2023 Ram 2500/3500, 2018-2022 Dodge Charger and 2018-2024 Dodge Durango (Not for Use with Core-R and C399S)
C399K4	2020-2021 Ford Interceptor Utility Gateway Installation Kit for C399, for Use WITHOUT Ford 61B Factory Option (Not for Use with Core-R and C399S)
C399K5	2024 Ford E-Series, 2020-2021 Ford Expedition, 2020-2022 Ford F-250/F-350/F-450/F-550/F-600 Super Duty and 2020-2021 Ford Transit Gateway Installation Kit for C399 (Not for Use with Core-R and C399S)
C399K6	2021-2022 Chevy Tahoe and 2021-2022 Chevy Suburban Installation Kit for C399 (Not for Use with Core-R and C399S)
C399K7	2021-2023 Ford F-150 PPV, 2022-2024 Ford F-150 Lightning, 2020-2024 Ford Interceptor Utility, 2022-2023 Ford Escape, 2022-2024 Ford Expedition, 2021-2024 Ford Mustang Mach-E, 2024 Ford Maverick, and 2022-2024 Ford Ranger Installation Kit for C399 (Not for Use with Core-R and C399S)
C399K8	2021-2022 Tesla Model Y Installation Kit (Not for Use with Core-R and C399S)
C399K9	2022-2023 Chevy Silverado HD 2500-3500 (Not for Use with Core-R and C399S)
C399SP	SCANport™ Installation Kit for C399, See Vehicle Outfitter for Available Vehicle Make/Model/Year (Not for Use with Core-R and Core-S®)

OBDII CANPORT INSTALLATION KITS FOR CORE-R® AND CORE-S®

C399RK1	OBDII CANport Installation Kit for C399R and C399S Only, for 2020-2022 Ford Interceptor Utility Used with Factory Option 61B, 2018-2022 Ford F-250/350
C399RK2	OBDII CANport Installation Kit for C399R Only, for 2019-2021 Chevy Silverado 1500 SSV (Body Style), 2019-2021 Chevy Colorado 1500
C399RK3	OBDII CANport Installation Kit for C399R and C399S Only, for 2019-2024 Ram 1500, 2021-2023 Ram 2500/3500, 2018-2022 Dodge Charger and 2018-2024 Dodge Durango
C399RK4	Installation Kit for C399R and C399S Only, for 2020 Ford Interceptor Utility Gateway, for Use WITHOUT Ford 61B Factory Option
C399RK5	Installation Kit for C399R and C399S Only, for 2024 Ford E-Series, 2020-2021 Ford Expedition, 2020-2022 Ford F-250/F-350/F-450/F-550/F-600 Super Duty, 2020-2021 Ford Transit Gateway and 2024 Ford E-Series
C399RK6	Installation Kit for C399R and C399S Only, for 2021-2022 Chevy Tahoe and 2021-2022 Chevy Suburban
C399RK7	Installation Kit for C399R and C399S Only, for 2021-2023 Ford F-150 PPV, 2022-2024 Ford F-150 Lightning, 2020-2024 Ford Interceptor Utility, 2022-2023 Ford Escape, 2022-2024 Ford Expedition, 2024 Ford Maverick, 2021-2024 Ford Mustang Mach-E and 2022-2024 Ford Ranger
C399RK8	Installation Kit for C399R and C399S Only, for 2021-2022 Tesla Model Y
C399RK9	Installation Kit for C399R and C399S Only, for 2022-2023 Chevy Silverado HD 2500-3500
C399RSP	SCANport Installation Kit for C399R and C399S, See Vehicle Outfitter for Available Vehicle Make/Model/Year (Not for Use with Core C399)

Note: Core-S utilizes the Core-R OBDII Cable. Please make sure that you use the C399RK* when specifying Core-S. The C399K* will not work as it uses a different connector.

SYSTEM EXPANSIONS

CEM8	8 Output, 4 Input WeCanX Expansion Module
CEM16	16 Output, 4 Input WeCanX Expansion Module
CEM16D	16 Output, 4 Input WeCanX Expansion Module, 10-30 VDC
CEM24	24 Output WeCanX Expansion Module, 10-30 VDC
CEM4HC	WeCanX High Current Remote Expansion Module, 4-15 Amp Output
CTA	WeCanX Traffic Advisor™ Remote Module, Traffic Advisor Purchased Separately

OPTIONS

CV2V	Vehicle-to-Vehicle Sync Module, Includes Internal Antenna
WCCBL100	WeCanX® Communication Cable, Bulk, 100'
WCXJB12	WeCanX Junction Box, 12 WeCanX Data Connection Points, Allows Up to 11 WCX Devices to Be Connected to Core Control System



Scan the QR code or visit vehicleoutfitter.whelen.com for a complete list of vehicle fitment options.

⚠ WARNING: This product may contain chemicals known to the State of California to cause cancer and birth defects or other reproductive harm. For more information, visit whelen.com/regulatory.

WHELEN
MANUFACTURED IN AMERICA

295 Series Electronic Sirens



Features available across product family. May not apply to every model.



295SLSA1

FEATURES

- Combination On/Off and horn ring transfer switch
- Models available with SI TEST®, a silent, self-diagnostic indicator of siren or speaker failure
- Input polarity protection
- Recess or bail bracket for under dash mounting

Model	Description
295SDA1	Dual-Tone Siren, Full Function Control Head
295SSA1	Single-Tone Siren, Full Function Control Head
295SLSA1	Siren Amplifier, Scan-Lock™ Siren Tones
295HFS2	Remote Siren Amplifier (Flush Mount Head)
295HFS2X	Remote Siren Amplifier (Flush Mount Head), Dual Amplifiers, Meets CA Title 13 Requirements
295SLSA6	Single Unit Siren with Control Head; Park Kill, Timed Out Relay and Scan-Lock Siren Tones
295HFSA7	Remote Dual Siren Amplifier, Flush Mount Control Head, Meets CA Title 13 Requirements
295HFSC9	Self-Contained Full Function Siren, Removable Microphone
295SL100	Full Function Siren, Heavy-Duty Microphone
295SL101	Full Function Siren, Heavy-Duty Plug-In Microphone, Volume Control Knob

Consult current price list for full list of available options at whelen.com/literature

DIMENSIONS

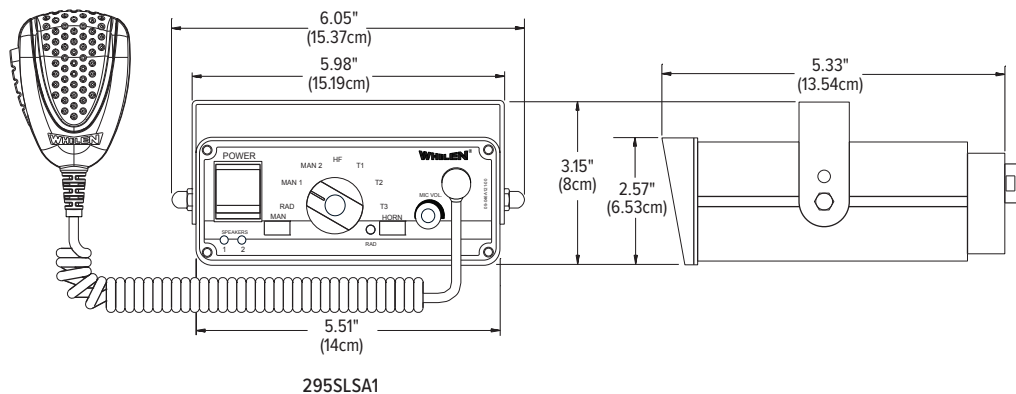

Howler™ Siren System



Features available across product family. May not apply to every model.



Chowler



Howler



FEATURES

- Low-frequency siren and speaker system
- Provides deep tones to penetrate other vehicles
- Howler is an add-on to any 100/200-watt siren amplifier and is not a replacement to the vehicle's primary siren
- Uses low frequency tones to synchronize with the vehicle's primary siren tones
- Works with any sweeping, Hi/Low, or electronic mechanical tones generated by the primary siren
- Certain vehicle models may utilize single or dual speaker systems

Model	Series	Speakers	Output	VDC	Mounting
HWLUNI	Howler	1	100-Watt	12	Universal Mounting Bracket
HWLDC15					2015-2023 Dodge Charger
HWLFE29					2020-2025 Ford Police Interceptor Utility
HOWLER	Howler	2	200-Watt	12	Optional Vehicle-Specific Mounting Bracket Available
CHOWLER					Optional Vehicle-Specific Mounting Bracket Available
CHWLUNI	Howler and WeCanX® Howler	1	100-Watt	12	Universal Mounting Bracket
CHWLDC15					2015-2023 Dodge Charger
CHWLFE29					2020-2025 Ford Police Interceptor Utility
HSB15					2015-2023 Dodge Charger
HSB4					2008-2020 Ford E-Series
HSB31					2019-2024 RAM 1500, Includes Built-In Mounting for SA315 Speaker (Not for Use on Vehicles Equipped with Active Air Dam)
HSB28					2019-2024 Chevy Silverado 1500 SSV
HSB22					2011-2023 Ford F-250/F-350, 2017-2023 F-450/F-550, 2018-2023 F-600
HSB23					Universal Mounting Bracket
HSB27					2018-2021 Ford Expedition SSV, Includes Built-In Mounting for SA315P/SA315U Speaker
HSB29					2020-2025 Ford Police Interceptor Utility
HSB30					2019-2020 Ram 4500/5500
HSB32					2021-2024 Chevy Tahoe PPV/SSV, 2024 Chevy Suburban
HSB33					2021-2022 Tesla Model Y
HSB34					2021-2024 Ford Mustang Mach-E
HSB35					2021-2024 Ford F-150, 2017-2024 Ford F-250/350/450/550, 2018-2024 Ford Expedition

Consult current price list for full list of available options at whelen.com/literature

DIMENSIONS

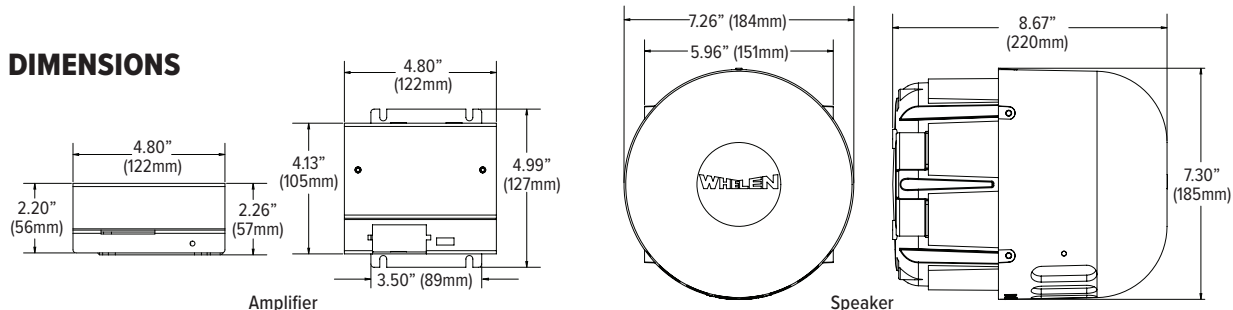

⚠ WARNING: This product may contain chemicals known to the State of California to cause cancer and birth defects or other reproductive harm. For more information, visit whelen.com/regulatory.

Economical Sirens & Airhorns



Features available across product family.
May not apply to every model.



BETA1



ALPHASL



WPA3BM

PAP112

FEATURES

- Alpha™ sirens deliver 100 or 200 watts of siren warning power, Hands-Free operation, multiple warning tones, and horn ring override capabilities
- Beta™ sirens meet budget sensitive demands for 200-watt siren warning performance, public address, radio repeat capability, and Hands-Free operation
- WPA sirens with public address feature a water resistant control head and 2 lighted rocker switches for lights/auxiliary and Wail/Yelp, and 2 non-lighted switches for Override/Airhorn and volume Hi/Low
- Power Airhorn™ siren amplifiers create the same familiar airhorn sound used by Police, Fire, and EMS in any type of vehicle

Model	Description
ALPHA12S	Alpha Series, Self-Contained Siren, Faceplate Switches
ALPHASL	Alpha Series, Remote Siren, Use with Remote Switches
BETA112R	Beta Series, Full Function Remote Siren, Use with Remote Switches
BETA1	Beta Series, Full Function Control Head Only, 15' (4.57m) Interconnect Harness
BETA2	Beta Series, Full Function Control Head Only, Weather Resistant, 20' (6.1m) Cable
WPA112	WPA Series, Waterproof Siren Amplifier, for a Single 100-Watt Speaker
WPA3BM	WPA Series, Full Function Control Head, Waterproof Switches and Microphone Jack, 20' (6.1m) Cable
PAH112	PA Series, Airhorn Tone Only Siren, for a Single 100-Watt Speaker
PAP112	PA Series, Airhorn Tone Plus Public Address Siren, Includes Microphone

Consult current price list for full list of available options at whelen.com/literature

Siren Speakers



Features available across product family.
May not apply to every model.

FEATURES

- SA315 and SA314 Series for bumper, concealed or flange mount, installs to vehicle's cross member in minutes
- UnderPro™ ambulance speakers are left or right side mounted

Model	Description
SA315U	Projector™ Series Nylon Composite, Multi-Port Speaker
SA315P	Projector Series Nylon Composite, Multi-Port Speaker
SA314A	Projector Series Small Profile Cast Aluminum Speaker
SA314B	Projector Series Small Profile Cast Aluminum Speaker, Black Epoxy Coated Finish
SP123BMC	Projector Series Bumper Mount Speaker

Consult current price list for full list of available options at whelen.com/literature

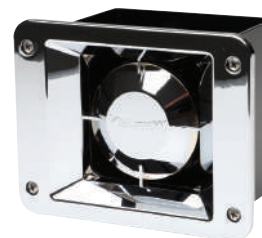

SP123BMC



SA315U



SA314A

Flashers & Switches

5YR   IP67

Features available across product family.
May not apply to every model.



AFL530

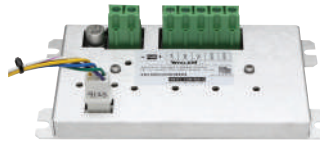

AFM560

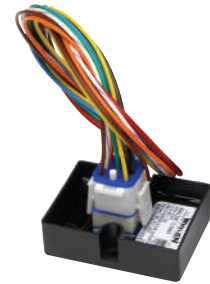

SSFPOS



ULF44



SLFLASH



PLF46



PCC10W



PCCS9RW

Model	Description
PCCS9RW	Switch Control for Standard Switching
PCCS9LW	Programmable Switch Control for Liberty™ II & Freedom® IV Lightbars
PCC4W	Switch Box, Four 25 Amp SPST Switches
PCC6W	Switch Box, Six 25 Amp SPST Switches
PCC6W1	Switch Box, Five 25 Amp SPST Switches and a Momentary Switch
PCC10W	Switch Box, Ten 25 Amp SPST Switches
PCC10W1	Switch Box, Nine 25 Amp SPST Switches and a Momentary Switch
PCC8R	8-Position Key Pad, Remote Relay Module
AFM1660	16-Outlet Flasher for Halogen, LED or Super-LED® Ambulance Lightheads
AFM560	5-Outlet Flasher for Halogen, LED or Super-LED Ambulance Lightheads
AFL530	5-Outlet Flasher for LED, or Super-LED Ambulance Lightheads
SSFPOS	2-Outlet Flasher for Halogen, LED, or Super-LED Headlight/Grille Lights
UHF2150A	2-Outlet Flasher with Relay, for Halogen, LED, or Super-LED Headlight/Grille Lights
ULF44	4-Outlet Flasher for LED or Super-LED Lightheads
SLFLASH	8-Outlet Flasher for LED Lightheads
PLF46	Programmable Light Flasher, Four Inputs, Six Outputs (30 Amps Total), Includes DVI and Steady-Lock®

Consult current price list for full list of available options at whelen.com/literature

⚠ WARNING: This product may contain chemicals known to the State of California to cause cancer and birth defects or other reproductive harm. For more information, visit whelen.com/regulatory.

PRODUCT INDEX

0S™ Series	45	Howler™ Siren System	87	Pioneer Plus™	67
2" Round Series	48	Inner Edge® RST™ Series.....	23	Pioneer Plus™ Surface Mount	69
3" Round Series	48	Inner Edge® XLP Series.....	22	Pioneer SlimLine™	70
4" Round Series.....	48	Inner Edge FST™ Series.....	23	Pioneer Summit™ Brow Light and Pioneer Summit.....	68
295 Series Electronic Sirens	86	Interior Lights	74, 75	R316 & R416 Series.....	59
400 Series	37	ION® Series	44	Rubber Housing Spot/Floodlights	76
400 Series Plus	37	ION® V-Series™	42	Scene Lights.....	73
500 Series.....	36	Justice® Series	14	Siren Speakers	88
600 Series.....	36	L31 & L32 Super-LED® Series.....	60	SlimLighter™	81
600 EZ Scene Light™	65	Legacy™ Series.....	20	SpitFire® ION® Series.....	81
700 Series	35	Liberty™ II Series.....	12	Strip-Lite™ Plus Sequencing Light	41
900 Series.....	35	LINV2™ V-Series™	45	Strip-Lite™ Plus XL Tank Light.....	41
900 EZ Scene Light™	65	M2 & M4 Series	34	TIR3, LIN3, & LINZ6™ Series.....	69
4500 Build-A-Bar Series.....	21	M6 EZ Scene Light™	64	Tracer™ WeCanX™	26
Arges® Remote Spotlight	64	M6 & M7 Series	33	Traffic Advisor Dominator™ Series.....	53
Avenger® II Series.....	80	M9 EZ Scene Light™	64	Traffic Advisor Flat Mount	54
B6 Series Combination Tailboard Lighting.....	58	M9 Series	32	Traffic Advisor TAC8 (Economy).....	55
Back-Up Lights	52	Mega T-Series™	38	Traffic Advisor™ 2200 Series.....	53
Brake/Tail/Turn Lights.....	50	Micro Freedom® Series.....	30	Traffic Advisor™ Front Load	55
CenCom Core®	83	Micron™ Series	43	Traffic Advisor™ Rear Slot Mount.....	54
Core-R®	83	Mini Edge® 9X Series.....	30	T-Series™	39
Core-S®	83	Mini Freedom™ IV Series	29	Turn Signals	51
Dominator™ & Dominator Plus™ Series	25	Mini T-Series™	40	U-Series™	42
Economical Sirens & Airhorns	88	NFPA Freedom IV Lightbars	10	V23™ Series	43
Edge® 9X Series.....	16	NFPA Justice Lightbars.....	14	Vertex™ Series	47
Field Series® Brow Light	62	Outer Edge® Series.....	24	VXE™ Series.....	46
Flashers & Switches	89	PAR-36 & PAR-46.....	77	WeCanX® 2250.....	18
Freedom® IV DUO™ & DYAD™ Series	10	PAR Replacement Lamps	78	Whelen Cloud Platform®	6
Freedom® IV Rota-Beam™ Series	9	Pioneer Micro™	71	WorkSide™	61
Handheld Spot/Floodlights	76	Pioneer Nano™	72		

LIGHTING CERTIFICATIONS

KKK-A-1822F - Federal Ambulance Specification

CA, Title 13, Article 22 (Red, Blue and Amber Lighthead)

WARNING LAMPS AND DEVICES:

SAE J595 - Directional Flashing Optical Warning Devices for Authorized Emergency, Maintenance, and Service Vehicles (Aug 21)

SAE J845 - Optical Warning Devices for Authorized Emergency, Maintenance, and Service Vehicles (Aug 21)

Test Procedures and Materials:

SAE J575 - Test Methods and Equipment for Lighting Devices for Use on Vehicles Less than 203 cm in Overall Width (Apr 21)

SAE J578 - Chromaticity Requirements for Ground Vehicle Lamps and Lighting Equipment (Apr 20)

SAE J2139 - Tests for Signal and Marking Devices Used on Vehicles 203 cm or More in Overall Width (Dec 14)

SIGNALING AND MARKING LIGHTING DEVICES AND SYSTEMS:

FMVSS 108 - Federal Motor Vehicle Safety Standards

NFPA 1900 - Standard for Aircraft Rescue and Firefighting Vehicles, Automotive Fire Apparatus, Wildland Fire Apparatus, and Automotive Ambulances (Jan 24)

SAE J585 - Tail Lamps (Rear Position Lamps) for Use on Motor Vehicles Less than 203 cm in Overall Width (Jun 14)

SAE J586 - Stop Lamps for Use on Motor Vehicles Less than 203 cm in Overall Width (May 16)

SAE J588 - Turn Signal Lamps for Use on Motor Vehicles Less than 203 cm in Overall Width (Mar 21)

SAE J592 - Sidemarkers Lamps for Use on Road Vehicles Less than 203 cm in Overall Width (Sep 16)

SAE J593 - Backup Lamp (Reversing Lamp) (Oct 6)

SAE J914 - Side Turn Signal Lamps for Vehicles Less than 12 m in Length (Aug 14)

SAE J1432 - Rear High Mounted Stop Lamps and Rear High Mounted Turn Signal Lamps for Use on Vehicles 203 cm or More in Overall Width (Jan 16)

SAE J1889 - LED Signal and Marking Lighting Devices (Jul 19)

SAE J1957 - Center High Mounted Stop Lamp Standard for Vehicles Less than 203 cm Overall Width (Jun 11)

SAE J2039 - Side Turn Signal Lamp for Long Vehicles (Aug 11)

SAE J2040 - Tail Lamps (Rear Position Lamps) for Use on Vehicles 203 cm or More in Overall Width (Jan 16)

SAE J2042 - Clearance, Sidemarkers, and Identification Lamps for On-Road Vehicles 203 cm or More in Overall Width (May 18)

SAE J2261 - Stop Lamps and Front- and Rear-Turn Signal Lamps for Use on Motor Vehicles 203 cm or More in Overall Width (July 16)

IP67 - Ingress Protection (IP) rating that indicates a device is protected from water and dust.

Notice:

Dimensions indicated for products are within $\pm 1/16"$ (1.58mm) tolerance. Metric equivalents are rounded to nearest whole number. For special applications requiring more precise measurement, contact factory.

Prior to using any interior light, consult your vehicle's owner manual to insure proper use with air bag safety systems.

The use of a magnetic or suction mounted beacon on the roof of a vehicle in motion is not recommended, and is at the sole discretion and risk of the user.

ICON LEGEND

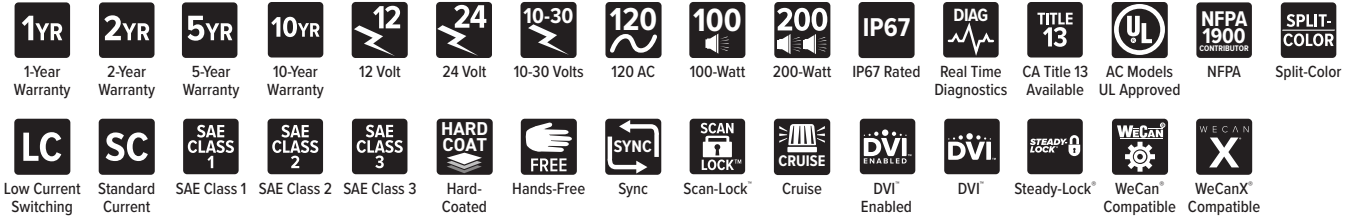

BroadBand Blue™

BroadBand Blue delivers a higher intensity, creates a larger optical image, and produces a more consistent color, all while being easier on the eyes - especially at night.

Conformal Coating

A thin material that conforms to the contours of the PCB to protect the electronic components from harsh environments and impact.

DUO™

Two-color interleaved LEDs

DVI™

DVI patterns gradually increase and decrease warning light intensity, which better conveys visual information to approaching motorists at night. These patterns clearly indicate when a vehicle is parked and improves a driver's ability to safely navigate around a work zone.

DYAD™

Two-level technology

E Block™

Whelen's patented E Block technology protects against the elements by creating a watertight seal around a unit's stranded wires to prevent moisture from entering the lighthouse.

Encapsulated

Lighthoods are fully encapsulated for moisture and vibration resistance.

Hard-Coat

Whelen's industry-first innovative Hard-Coating process counteracts the effects of environmental and chemical damages to our lenses and domes.

Linear-LED® - (Super-LED®)

Whelen's optimized use of the latest generation of LEDs and unique reflector optics to produce highly intense light that has superior wide-angle visibility and rivals strobe in performance.

Low Current

Low current function wires require less than 0.25 amp to operate, allowing for simple operation of each lightbar function.

ProFocus™

Whelen's innovative single optic LED technology that can be customized and programmed as a spotlight or floodlight, with no moving parts.

Proclera® Silicone Optics

Whelen's innovative and efficient solution to distorted optical shape and fringe lighting. Proclera Optics feature 100% internal silicone optic technology, an increased ability to harness LED output and better direct and focus light, and a fully-filled square TIR optic to increase optic efficiency compared to a conventional circular TIR.

Rota-Beam™

Solid-state "rotating" technology, simulating the appearance of a rotating beacon without any moving parts or motors for long-life reliability.

Scan-Lock™

Whelen's advanced method of changing a products flash pattern. Scan-Lock utilizes an external wire to allow the user to cycle through the entire range of flash patterns, allowing for full customization.

Scan-Lock+™

The Scan-Lock+ app is the simplest way to change Whelen flash patterns. Designed for optimal convenience, Scan-Lock+ features an easy to use interface and utilizes a Bluetooth connection. Download the Scan-Lock+ app and browse, test, and assign Whelen flash patterns right from your phone.

SmartLED®

Whelen's distinctive use of self-contained electronics to power and flash a particular LED product. These products require no external flasher, ballast, or power supply to operate.

SOLO™

Single-color LEDs

Split

Two-color lighthead where each color fills half of the reflector

Standard Current

Lightbar functions are wired directly to the switching device and require switches that are matched to the current draw of the desired functions to be activated.

Steady-Lock®

A new feature in warning lighthoods that allows an installer to set the flash pattern to Steady automatically, when used with one of Whelen's CenCom Core® control systems.

Super-LED®

Whelen's innovative LED technology

Sync

Sync provides the ability to connect multiple Whelen devices to flash together or in alternating patterns. Products with this capability allow the user to create coordinating flashing schemes.

TIR - (Total Internal Reflection)

Whelen's optimized use of the latest generation of LEDs and unique reflector optics to produce highly intense light that can be directional in nature.

TRIO™

Three-color interleaved with independent control of color one, color two, and color three

WeCad™

Engineered for optimal accessibility, WeCad lightbar designer delivers the ability to design custom Whelen lightbars with every available option. Adding R65 compliant options is simple, and a bill of materials will be generated to make ordering fast and easy.

WeCan®

Whelen's proprietary CAN-based communication system.

WeCanX®

Whelen's smartest and most powerful CAN-based communication system. WeCanX provides true system synchronization, DVI flash patterns, greater speed capabilities, expanded peripheral add-ons, and full support of diagnostics.

FIRE & EMS

PROFESSIONAL WARNING AND LIGHTING

A comprehensive guide to Whelen's
lighting and warning products

Distributed by:

WHELEN[®]
MANUFACTURED IN AMERICA

@WhelenENG

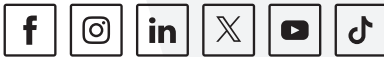

NASCAR[™]
OFFICIAL WARNING LIGHTS

Preferred Warning Lights of



Whelen Engineering Company
(860) 526-9504
www.whelen.com

Whelen Engineering reserves
the right to upgrade and improve
products without notice.

© 2025 Whelen Engineering Company,
Inc. Printed in U.S.A.
Code No. 11032AF - 02/25

All products proudly designed, manufactured,
and assembled in the U.S.A.
• ISO 9001 Registered QMS